

Ampco Centrifugal Pumps

DATA SHEET

MODEL AC/AC+ 4410 4X4

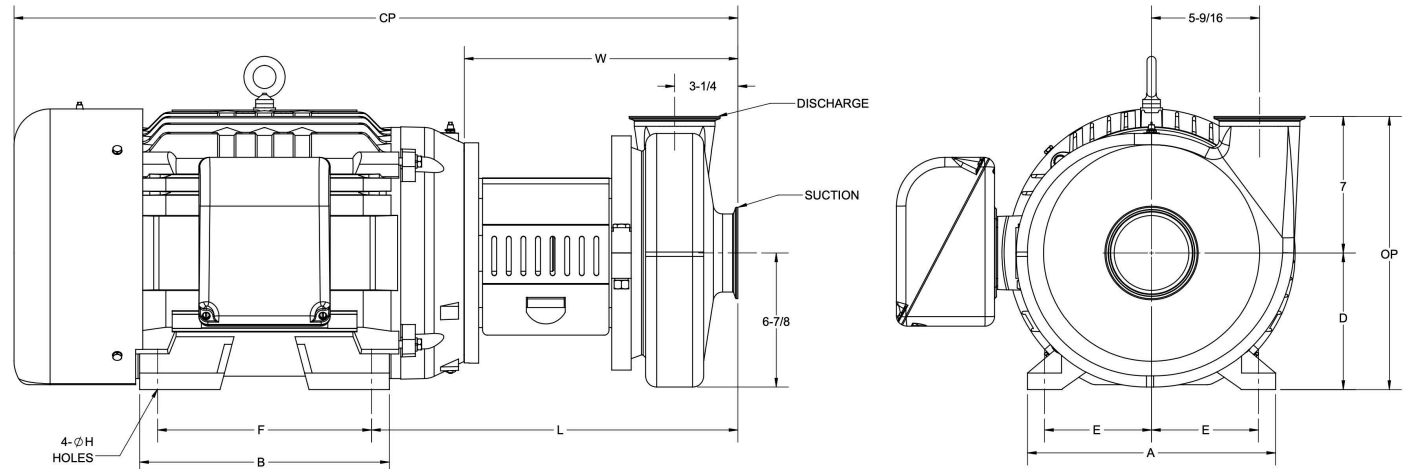
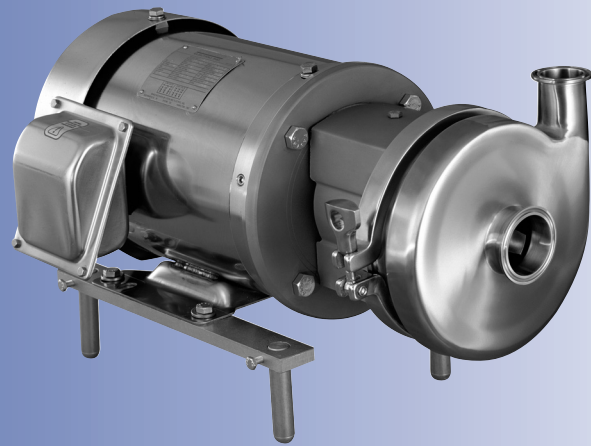

TEFC MOTOR			DIMENSIONS IN INCHES (For Reference Only)										APPROX WEIGHT (LBS)
HP	RPM	FRAME	A (typ)	B (typ)	D	E	F	ØH	L	W	CP	OP	
7-1/2	1750	213TC	9-1/2	8	5-1/4	4-1/4	5-1/2	13/32	17-11/16	13-3/8	28-1/4	12-1/4	230
10	1750	215TC	9-1/2	8	5-1/4	4-1/4	7	13/32	17-11/16	13-3/8	30	12-1/4	240
15	1750	254TC	11-1/2	11-1/2	6-1/4	5	8-1/4	17/32	18-1/8	13-3/8	30-5/8	13-1/4	358
20	1750	256TC	11-1/2	11-1/2	6-1/4	5	10	17/32	18-1/8	13-3/8	32-3/4	13-1/4	381
25	1750	284TC	12-3/4	12-3/4	7	5-1/2	9-1/2	17/32	18-13/16	14-1/16	36-7/16	14	514
30	1750	286TC	12-3/4	12-3/4	7	5-1/2	11	17/32	18-13/16	14-1/16	36-7/16	14	525
20	3500	256TC	11-1/2	11-1/2	6-1/4	5	10	17/32	18-1/8	13-3/8	32-3/4	13-1/4	375
25	3500	284TSC	12-3/4	12-3/4	7	5-1/2	9-1/2	17/32	18-13/16	14-1/16	36-7/16	14	474
30	3500	286TSC	12-3/4	12-3/4	7	5-1/2	11	17/32	18-13/16	14-1/16	36-7/16	14	496
40	3500	324TSC	14-1/2	14	8	6-1/4	10-1/2	21/32	20-3/4	15-1/2	38-3/16	15	617
50	3500	326TSC	14-1/2	14	8	6-1/4	12	21/32	20-3/4	15-1/2	38-3/16	15	726
60	3500	364TSC	16-1/2	14-1/2	9	7	11-1/4	21/32	21-3/8	15-1/2	40-7/16	16	867
75	3500	365TSC	16-1/2	14-1/2	9	7	12-1/4	21/32	21-3/8	15-1/2	40-7/16	16	893

MATERIAL SPECIFICATIONS

PART NAME	STAINLESS STEEL
Casing	316L Stainless
Backplate, Impeller, Stub Shaft	316L Stainless
Adapter	304 Stainless



Ampco Centrifugal Pumps

MODEL AC/AC+ 4410 4X4

Curves show approximate characteristics
based on clear 68° water.
Rated point is guaranteed.

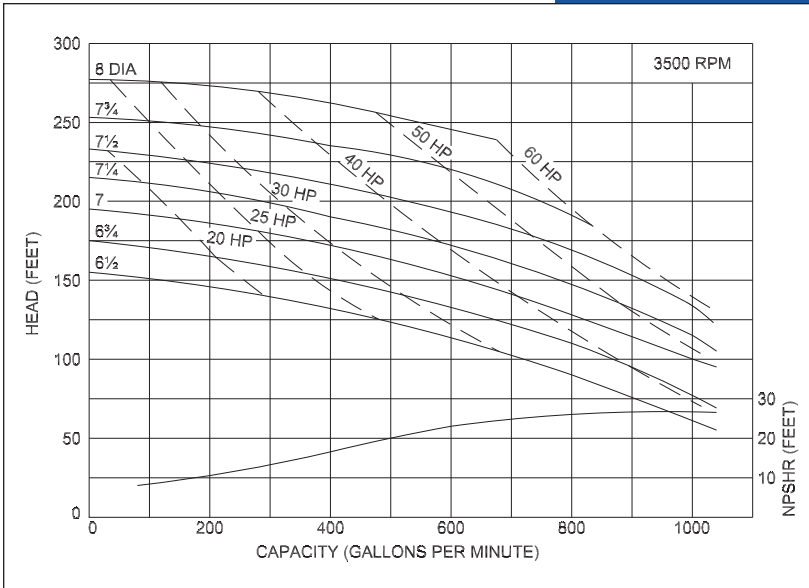

AC/AC+ Series pumps have standard stainless steel adapters and Type D, DG, & E seals available.

AC/AC+ Series pumps are in conformance with 3A sanitary standards for centrifugal and positive rotary pumps for milk and milk products,
Number 02-10.

AC/AC+ Series pumps have a standard 32RA (150 grit) finish, on all product contact surfaces.

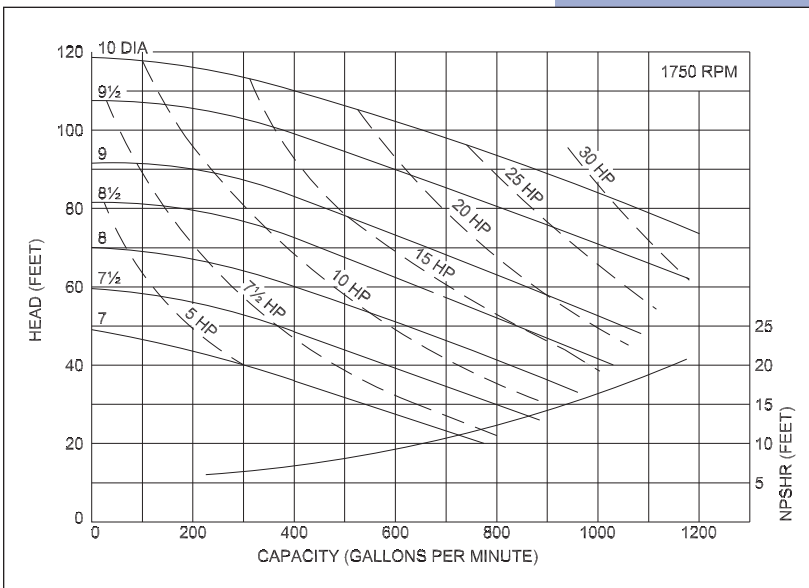
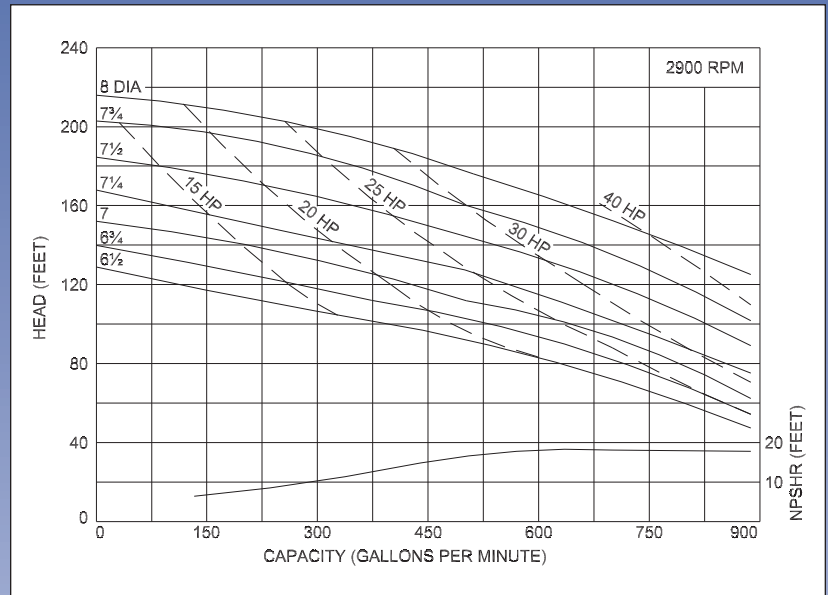

Ampco Pumps Company

2045 West Mill Road
Glendale, Wisconsin 53209
PHONE (414) 643-1852
FAX (414) 643-4452