

Ampco Centrifugal Pumps

DATA SHEET

Model CB+ 428 4x2

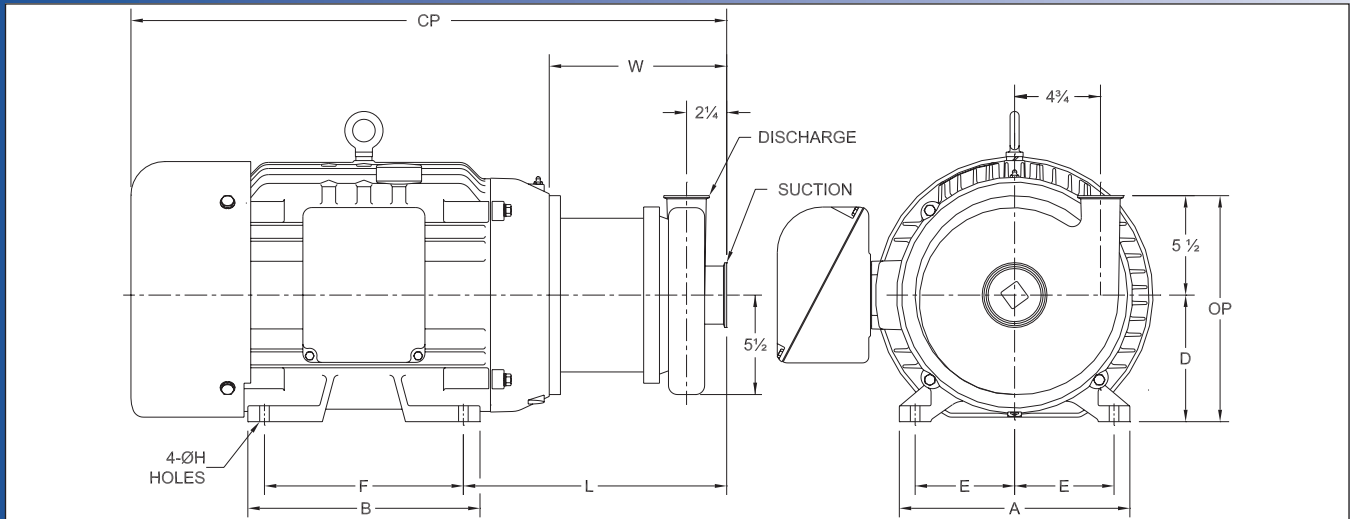
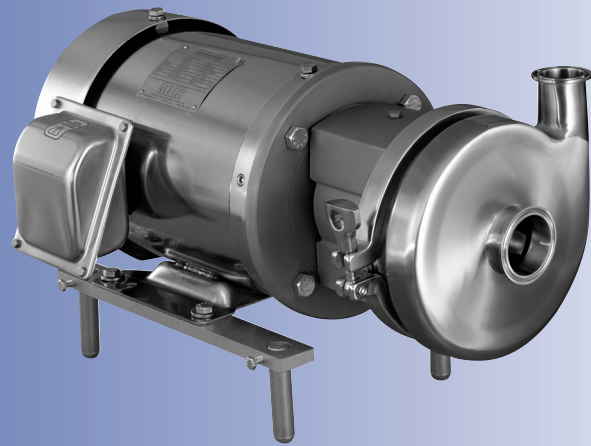

TEFC MOTOR			DIMENSIONS IN INCHES (For Reference Only)										APPROX WEIGHT (LBS)
HP	RPM	FRAME	A (typ)	B (typ)	D	E	F	ØH	L	W	CP	OP	
2	1750	145TC	6-1/2	6	3-1/2	2-3/4	5	11/32	11-9/16	8-13/16	19-7/16	9	97
3	1750	182TC	8-5/8	6-1/2	4-1/2	3-3/4	4-1/2	13/32	12-15/16	9-7/16	22-9/16	10	124
5	1750	184TC	8-5/8	6-1/2	4-1/2	3-3/4	5-1/2	13/32	12-15/16	9-7/16	23-15/16	10	131
7-1/2	1750	213TC	9-1/2	8	5-1/4	4-1/4	5-1/2	13/32	14-1/16	9-13/16	24-7/16	10-3/4	183
10	1750	215TC	9-1/2	8	5-1/4	4-1/4	7	13/32	14-1/16	9-13/16	26-3/16	10-3/4	193
5	3500	184TC	8-5/8	6-1/2	4-1/2	3-3/4	5-1/2	13/32	12-15/16	9-7/16	23-15/16	10	126
7-1/2	3500	184TC	8-5/8	6-1/2	4-1/2	3-3/4	5-1/2	13/32	12-15/16	9-7/16	23-15/16	10	144
7-1/2	3500	213TC	9-1/2	8	5-1/4	4-1/4	5-1/2	13/32	14-1/16	9-13/16	24-7/16	10-3/4	146
10	3500	215TC	9-1/2	8	5-1/4	4-1/4	7	13/32	14-1/16	9-13/16	26-3/16	10-3/4	179
15	3500	215TC	9-1/2	8	5-1/4	4-1/4	7	13/32	14-1/16	9-13/16	26-3/16	10-3/4	219
20	3500	256TC	11-1/2	11-1/2	6-1/4	5	10	17/32	15-7/16	10-11/16	28-5/16	11-3/4	328
25	3500	284TSC	12-3/4	12-3/4	7	5-1/2	9-1/2	17/32	16-1/16	11-5/16	31-1/16	12-1/2	420
30	3500	286TSC	12-3/4	12-3/4	7	5-1/2	11	17/32	16-1/16	11-5/16	34-7/16	12-1/2	442
40	3500	324TSC	14-1/2	14	8	6-1/4	10-1/2	21/32	17-1/8	11-7/8	34-3/8	13-1/2	549
50	3500	326TSC	14-1/2	14	8	6-1/4	12	21/32	17-1/8	11-7/8	36	13-1/2	651

MATERIAL SPECIFICATIONS

PART NAME	STAINLESS STEEL
Casing	316L Stainless
Backplate, Impeller, Stub Shaft	316L Stainless
Adapter	304 Stainless

Ampco Centrifugal Pumps

Model CB+ 428 4x2

Curves show approximate characteristics
based on clear 68° water.
Rated point is guaranteed.

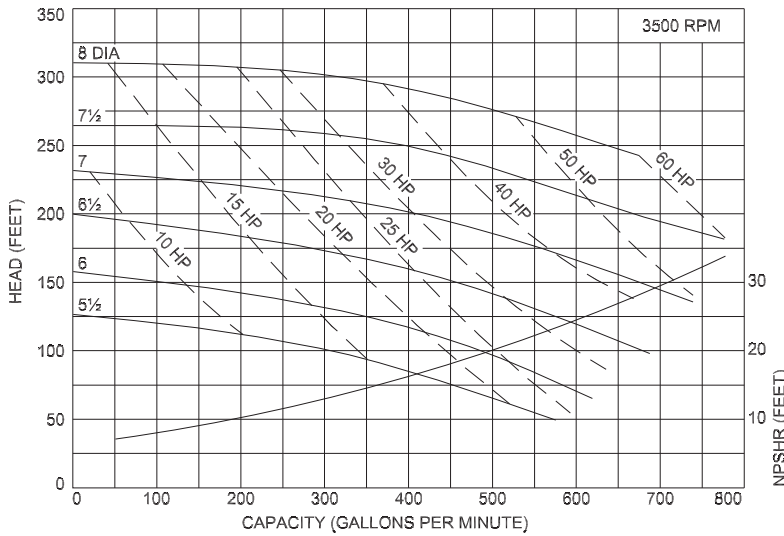

CB+ Series pumps have standard stainless steel adapters and utilize an internal seal.

CB+ Series pumps have a standard 32RA (150 grit) finish, on all product contact surfaces.

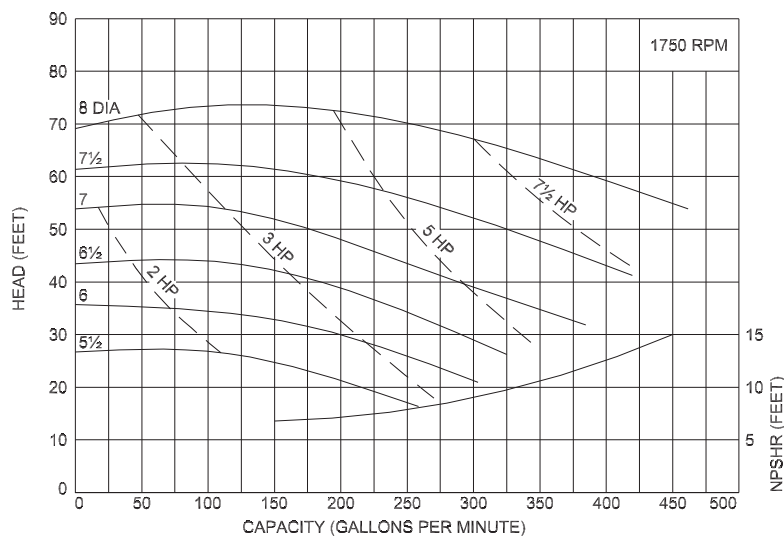
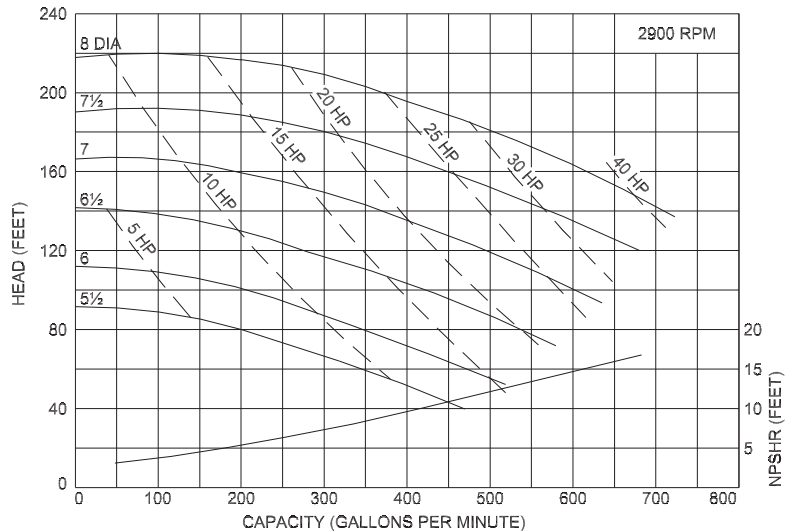

Ampco Pumps Company

2045 West Mill Road
Glendale, Wisconsin 53209
PHONE (414) 643-1852
FAX (414) 643-4452