

ELECTRONIC CATALOG NAVIGATION INSTRUCTIONS

Select by Pump Model:

If you know what pump you are looking for, you can use the 'Bookmarks' tab on the left and select the pump model which you are trying to access. Clicking in the Bookmark will take you to the page you are looking for.

If there are no tabs on the left (bookmarks, signatures, layers, pages), you can use the top menu to make them appear. Goto VIEW > SHOW/HIDE > NAVIGATION PANES > BOOKMARKS and they will appear.

Sample Pump ID Tag: See the illustration below for help identifying the location of the Model number and Serial number on the pump ID tag.

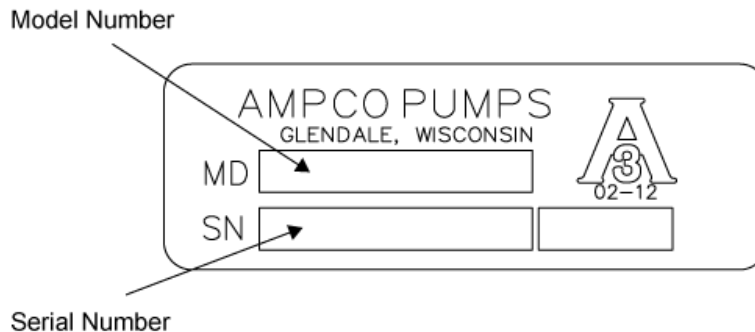

Please reference your serial number when ordering replacement parts.

Select by Part Number:

If you know an exact part number you are looking for, simply hit CONTROL+F and that will bring up the find feature. You may also use the menu, goto EDIT > FIND to bring up the same feature.

Type in your part number and it will show you all instances of that item in the catalog. If you only know some of the part number (i.e. SP328), that will also help and show all occurrences of those numbers together.

Be advised that partials of part number can return a large amount of results.

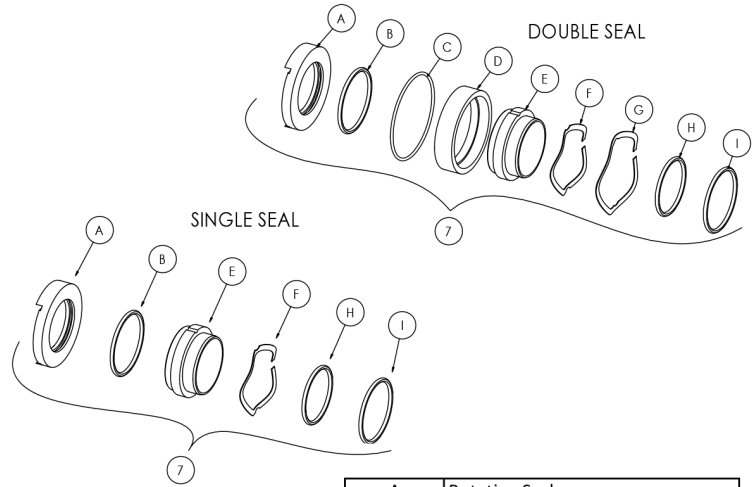
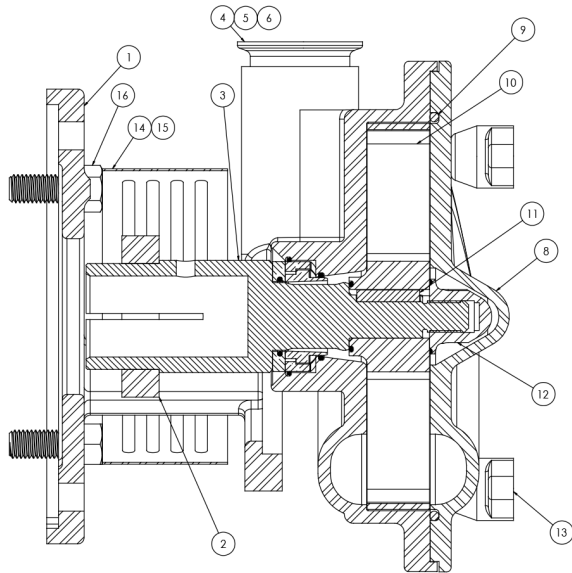

A	Rotating Seal
B	Rotating Seal O-Ring
C	Double Seal O-Ring
D	Double Seal
E	Stationary Seal
F	Single Seal Wave Spring
G	Double Seal Wave Spring
H	Single Seal O-Ring
I	Impeller O-Ring

Exploded View

Optional Items Shown in ITALICS

Ref #	Component Item No.	Description	Qty Per
1	SX10600097	ADAPTER,180-250TC FRAME SP	1
2	SX18000014	COLLAR,180TC,SHAFT LC	1
3	SX02000005	STUBSHAFT,180TC W/KEY SP	1
4	SV08610000	CASING,180-210TC,2 CLMP SP 210,215	1
5	GX10610400	CAPSCRW,HX,M12-1.75X30MM,18-8S HX HD	3
6	GX10610405	WASHER,LCK,1/2,18-8SS L SERIES	3
7	GS2600010-SC	KIT,SGL SEAL,C/N/V SP	1
	<i>GS2600012</i>	<i>KIT,SGL SEAL,C/C/V SP</i>	<i>1</i>
	<i>GS2600018-SC</i>	<i>KIT,DBL SEAL,C/N/N/V SP</i>	<i>1</i>
	<i>GS2600020</i>	<i>KIT,DBL SEAL,C/C/N/V SP</i>	<i>1</i>
8	SC08620000	COVER,210,2 CLAMP SP	1
9	GX80000334	GASKET,210/215,CVR,BUNA SP	1
	<i>GX80000351</i>	<i>GASKET,210/215,CVR,EPDM SP</i>	<i>1</i>
	<i>GX80000335</i>	<i>GASKET,210/215,CVR,VITON SP</i>	<i>1</i>
10	SI08630000	IMPELLER,210/215 SP	1
11	SX15000018	KEY,210-220 SP	1
12	SI54000007	NUT,735,IMP,250TC-280TC	1
13	SX03000028	NUT,WING SP	3
14	SX10620036	GUARD,210-225,SHAFT SP	1
15	GX48104020	CAPSCRW,HX,1/4-28X3/8,18-8SS HX HD	2
16	SC1710H-SS	CAPSCRW,HX,1/2-13X1,18-8SS HX HD	4

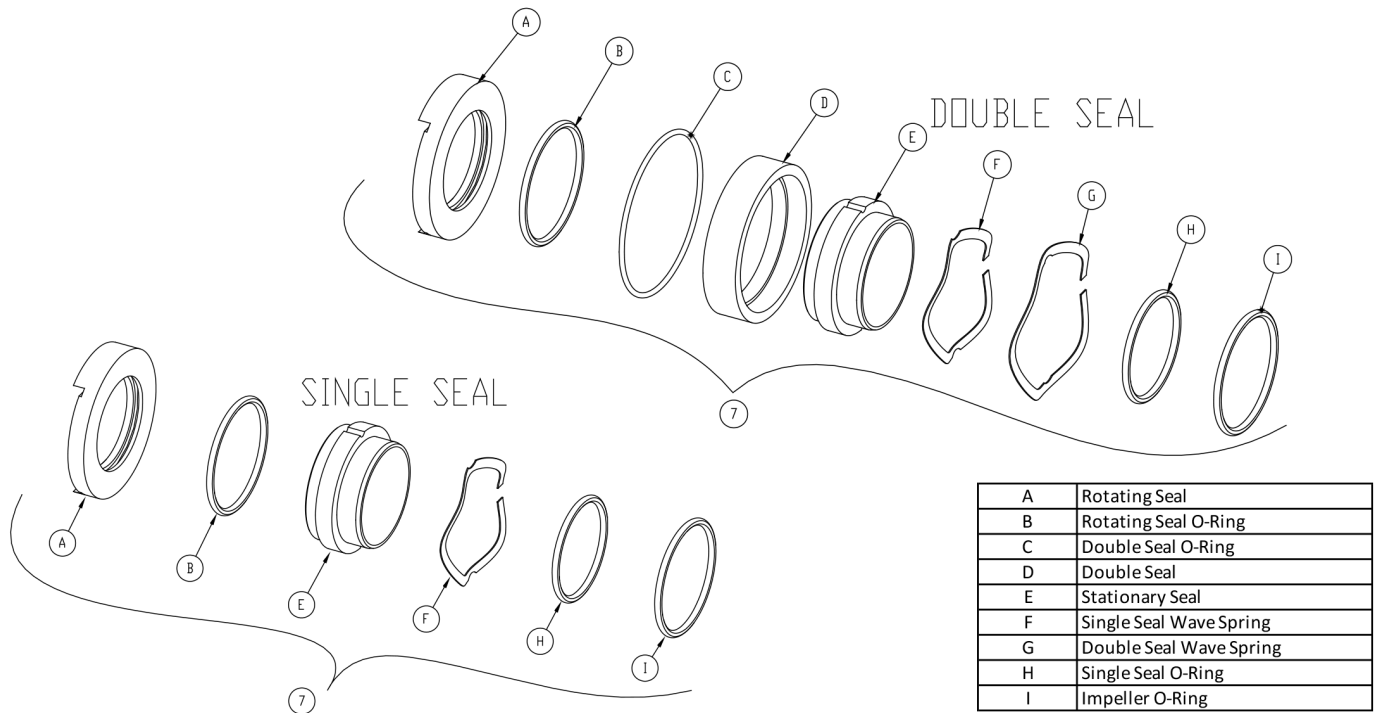

A	Rotating Seal
B	Rotating Seal O-Ring
C	Double Seal O-Ring
D	Double Seal
E	Stationary Seal
F	Single Seal Wave Spring
G	Double Seal Wave Spring
H	Single Seal O-Ring
I	Impeller O-Ring

Exploded View - Seal Only

Optional Items Shown in ITALICS

Ref #	Component Item No.	Description	Qty Per
7	GS2600010-SC	KIT,SGL SEAL,C/N/V SP	1
	<i>GS2600012</i>	<i>KIT,SGL SEAL,C/C/V SP</i>	<i>1</i>
	<i>GS2600018-SC</i>	<i>KIT,DBL SEAL,C/N/N/V SP</i>	<i>1</i>
	<i>GS2600020</i>	<i>KIT,DBL SEAL,C/C/N/V SP</i>	<i>1</i>

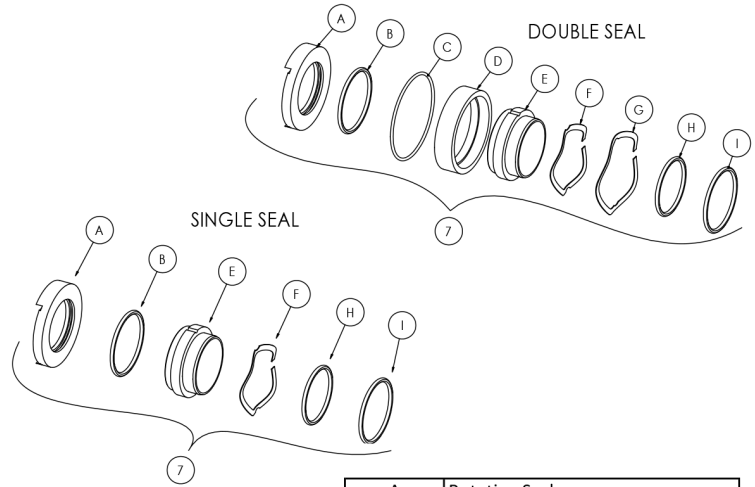
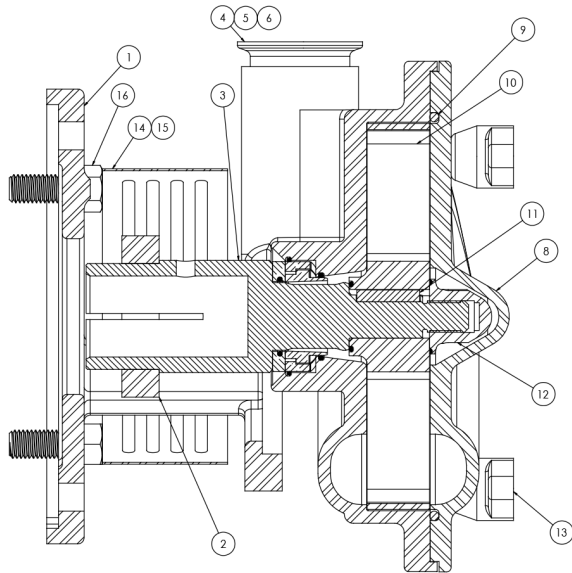

A	Rotating Seal
B	Rotating Seal O-Ring
C	Double Seal O-Ring
D	Double Seal
E	Stationary Seal
F	Single Seal Wave Spring
G	Double Seal Wave Spring
H	Single Seal O-Ring
I	Impeller O-Ring

Exploded View

Optional Items Shown in ITALICS

Ref #	Component Item No.	Description	Qty Per
1	SX10600097	ADAPTER,180-250TC FRAME SP	1
2	SX18000015	COLLAR,210TC,SHAFT LC	1
3	SX02000015	STUBSHAFT,210TC W/KEY SP	1
4	SV08610000	CASING,180-210TC,2 CLMP SP 210,215	1
5	GX10610400	CAPSCRW,HX,M12-1.75X30MM,18-8S HX HD	3
6	GX10610405	WASHER,LCK,1/2,18-8SS L SERIES	3
7	GS2600010-SC	KIT,SGL SEAL,C/N/V SP	1
	<i>GS2600012</i>	<i>KIT,SGL SEAL,C/C/V SP</i>	<i>1</i>
	<i>GS2600018-SC</i>	<i>KIT,DBL SEAL,C/N/N/V SP</i>	<i>1</i>
	<i>GS2600020</i>	<i>KIT,DBL SEAL,C/C/N/V SP</i>	<i>1</i>
8	SC08620000	COVER,210,2 CLAMP SP	1
9	GX80000334	GASKET,210/215,CVR,BUNA SP	1
	<i>GX80000351</i>	<i>GASKET,210/215,CVR,EPDM SP</i>	<i>1</i>
	<i>GX80000335</i>	<i>GASKET,210/215,CVR,VITON SP</i>	<i>1</i>
10	SI08630000	IMPELLER,210/215 SP	1
11	SX15000018	KEY,210-220 SP	1
12	SI54000007	NUT,735,IMP,250TC-280TC	1
13	SX03000028	NUT,WING SP	3
14	SX10620036	GUARD,210-225,SHAFT SP	1
15	GX48104020	CAPSCRW,HX,1/4-28X3/8,18-8SS HX HD	2
16	SC1710H-SS	CAPSCRW,HX,1/2-13X1,18-8SS HX HD	4

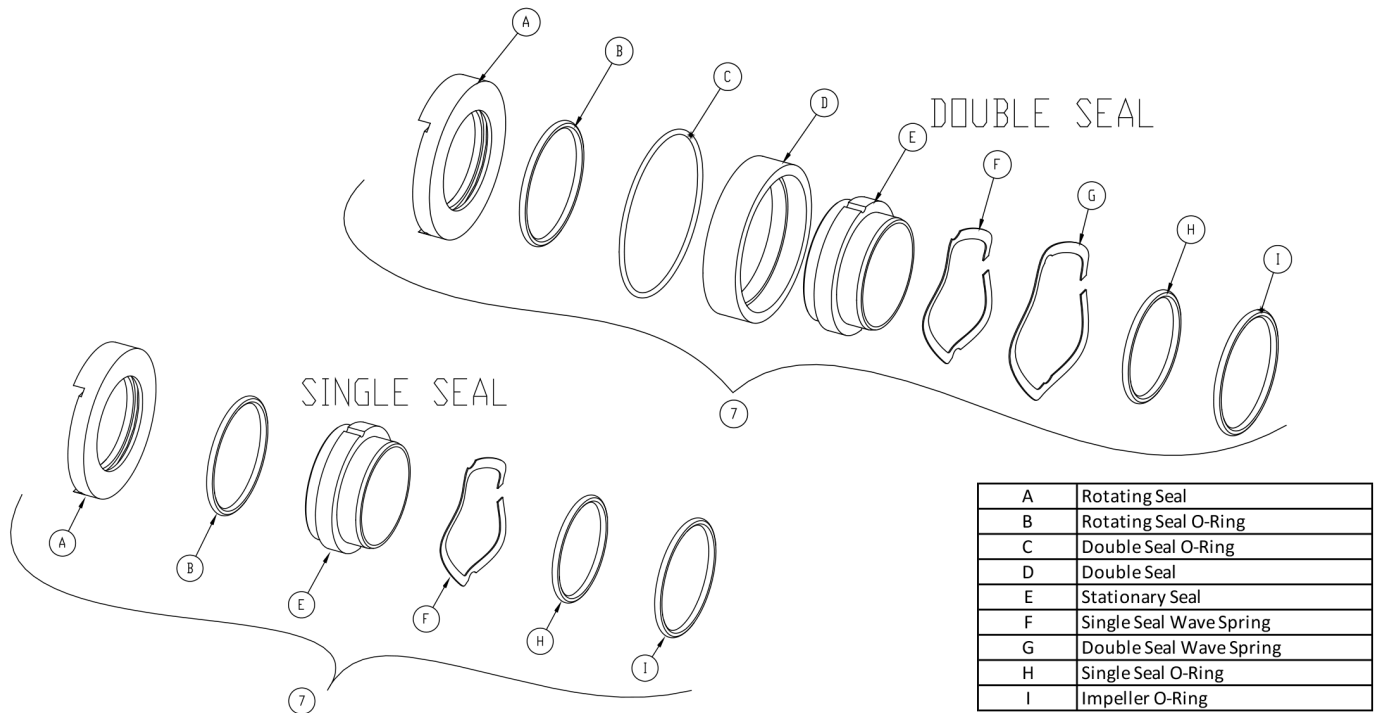

A	Rotating Seal
B	Rotating Seal O-Ring
C	Double Seal O-Ring
D	Double Seal
E	Stationary Seal
F	Single Seal Wave Spring
G	Double Seal Wave Spring
H	Single Seal O-Ring
I	Impeller O-Ring

Exploded View - Seal Only

Optional Items Shown in ITALICS

Ref #	Component Item No.	Description	Qty Per
7	GS2600010-SC	KIT,SGL SEAL,C/N/V SP	1
	<i>GS2600012</i>	<i>KIT,SGL SEAL,C/C/V SP</i>	<i>1</i>
	<i>GS2600018-SC</i>	<i>KIT,DBL SEAL,C/N/N/V SP</i>	<i>1</i>
	<i>GS2600020</i>	<i>KIT,DBL SEAL,C/C/N/V SP</i>	<i>1</i>

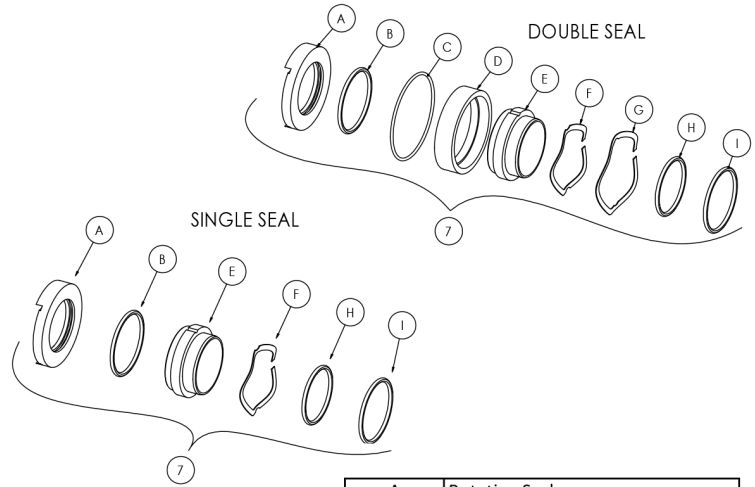
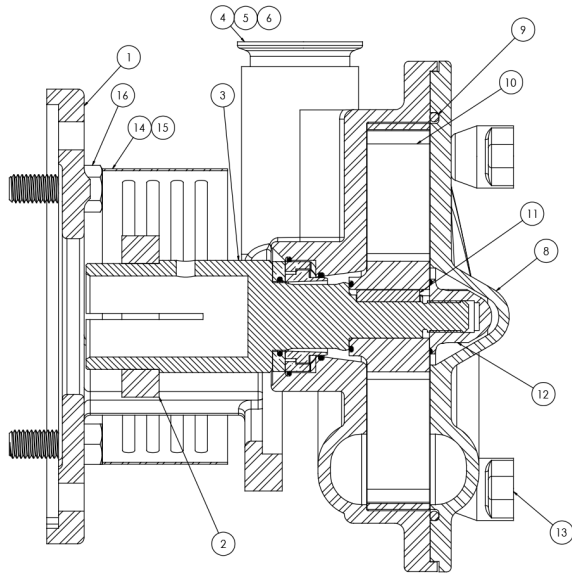

A	Rotating Seal
B	Rotating Seal O-Ring
C	Double Seal O-Ring
D	Double Seal
E	Stationary Seal
F	Single Seal Wave Spring
G	Double Seal Wave Spring
H	Single Seal O-Ring
I	Impeller O-Ring

Exploded View

Optional Items Shown in ITALICS

Ref #	Component Item No.	Description	Qty Per
1	SX10600897	***OBSOLETE*** ADAPTER,100/112 IEC FRAME	1
2	SX18000814	COLLAR,100/112 IEC,SHAFT,MTRIC	1
3	SX02000805	STUBSHAFT,100/112 IEC FRAME SP	1
4	SV08610000	CASING,180-210TC,2 CLMP SP 210,215	1
5	GX10610400	CAPSCRW,HX,M12-1.75X30MM,18-8S HX HD	3
6	GX10610405	WASHER,LCK,1/2,18-8SS L SERIES	3
7	GS2600010-SC	KIT,SGL SEAL,C/N/V SP	1
	<i>GS2600010-SC</i>	<i>KIT,SGL SEAL,C/N/V SP</i>	<i>1</i>
	<i>GS2600018-SC</i>	<i>KIT,DBL SEAL,C/N/N/V SP</i>	<i>1</i>
	<i>GS2600020</i>	<i>KIT,DBL SEAL,C/C/N/V SP</i>	<i>1</i>
8	SC08620000	COVER,210,2 CLAMP SP	1
9	GX80000334	GASKET,210/215,CVR,BUNA SP	1
	<i>GX80000351</i>	<i>GASKET,210/215,CVR,EPDM SP</i>	<i>1</i>
	<i>GX80000335</i>	<i>GASKET,210/215,CVR,VITON SP</i>	<i>1</i>
10	SI08630000	IMPELLER,210/215 SP	1
11	SX15000018	KEY,210-220 SP	1
12	SI54000007	NUT,735,IMP,250TC-280TC	1
13	SX03000020-ACRN	NUT,ACRN,R,M12-1.75.18-8SS L/SP SERIES	3
14	SX10620836	GUARD,100/215/220,SHAFT SP 100/112/132 IEC	1
15	GX48104021	SCREW,THUMB,1/4-28X3/8,304SS L SERIES	2
16	GX5516145	CAPSCRW,HX,M14-2.0X55MM,18-8SS HX HD	4
17	GX5516010	WASHER,LOCK,M14,18-8SS	4
	GX5516015	WASHER,FLAT,M14,18-8SS	8
18	GX5516000	NUT,HEX,M14-2.0,18-8SS HEX NUT	4

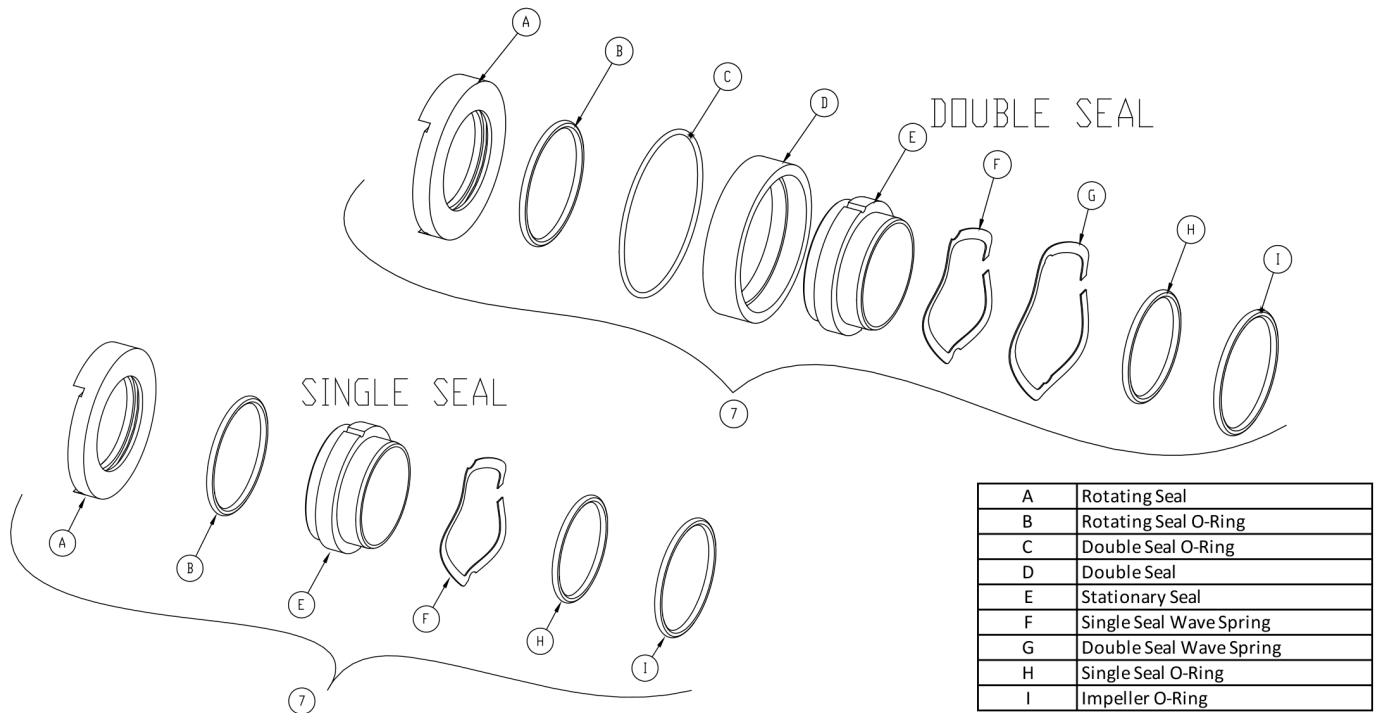

Exploded View - Seal Only

Optional Items Shown in ITALICS

Ref #	Component Item No.	Description	Qty Per
7	GS2600010-SC	KIT,SGL SEAL,C/N/V SP	1
	<i>GS2600010-SC</i>	<i>KIT,SGL SEAL,C/N/V SP</i>	<i>1</i>
	<i>GS2600018-SC</i>	<i>KIT,DBL SEAL,C/N/N/V SP</i>	<i>1</i>
	<i>GS2600020</i>	<i>KIT,DBL SEAL,C/C/N/V SP</i>	<i>1</i>

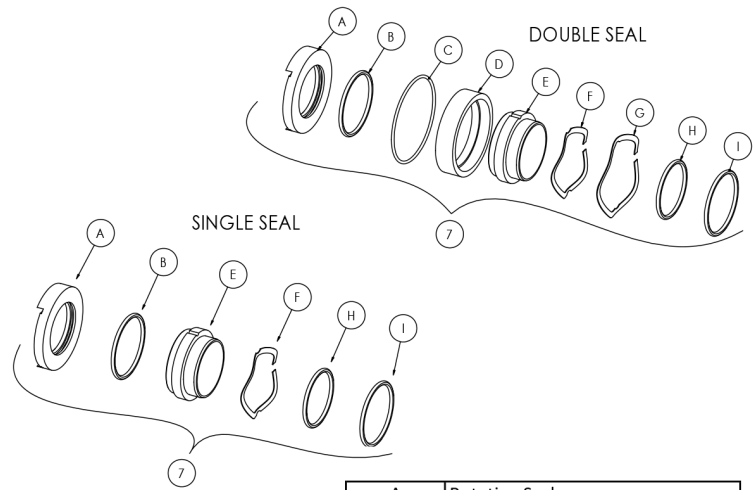
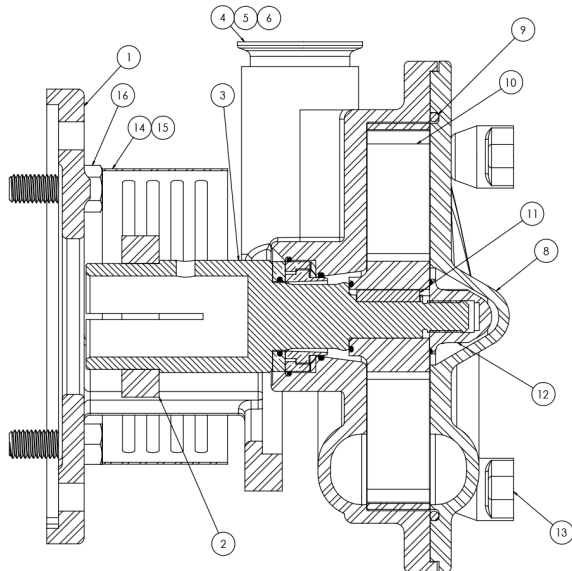

A	Rotating Seal
B	Rotating Seal O-Ring
C	Double Seal O-Ring
D	Double Seal
E	Stationary Seal
F	Single Seal Wave Spring
G	Double Seal Wave Spring
H	Single Seal O-Ring
I	Impeller O-Ring

Exploded View

Optional Items Shown in ITALICS

Ref #	Component Item No.	Description	Qty Per
1	SX10600097	ADAPTER,180-250TC FRAME SP	1
2	SX18000015	COLLAR,210TC,SHAFT LC	1
3	SX02000005	STUBSHAFT,180TC W/KEY SP	1
4	SV08610000	CASING,180-210TC,2 CLMP SP 210,215	1
5	GX10610400	CAPSCRW,HX,M12-1.75X30MM,18-8S HX HD	3
6	GX10610405	WASHER,LCK,1/2,18-8SS L SERIES	3
7	GS2600010-SC	KIT,SGL SEAL,C/N/V SP	1
	<i>GS2600010-SC</i>	<i>KIT,SGL SEAL,C/N/V SP</i>	<i>1</i>
	<i>GS2600018-SC</i>	<i>KIT,DBL SEAL,C/N/N/V SP</i>	<i>1</i>
	<i>GS2600020</i>	<i>KIT,DBL SEAL,C/C/N/V SP</i>	<i>1</i>
8	SC08620001	COVER,215,2 CLAMP SP	1
9	GX80000334	GASKET,210/215,CVR,BUNA SP	1
	<i>GX80000351</i>	<i>GASKET,210/215,CVR,EPDM SP</i>	<i>1</i>
	<i>GX80000335</i>	<i>GASKET,210/215,CVR,VITON SP</i>	<i>1</i>
10	SI08630000	IMPELLER,210/215 SP	1
11	SX15000018	KEY,210-220 SP	1
12	SI54000007	NUT,735,IMP,250TC-280TC	1
13	SX03000028	NUT,WING SP	3
14	SX10620036	GUARD,210-225,SHAFT SP	1
15	GX48104020	CAPSCRW,HX,1/4-28X3/8,18-8SS HX HD	2
16	SC1710H-SS	CAPSCRW,HX,1/2-13X1,18-8SS HX HD	4

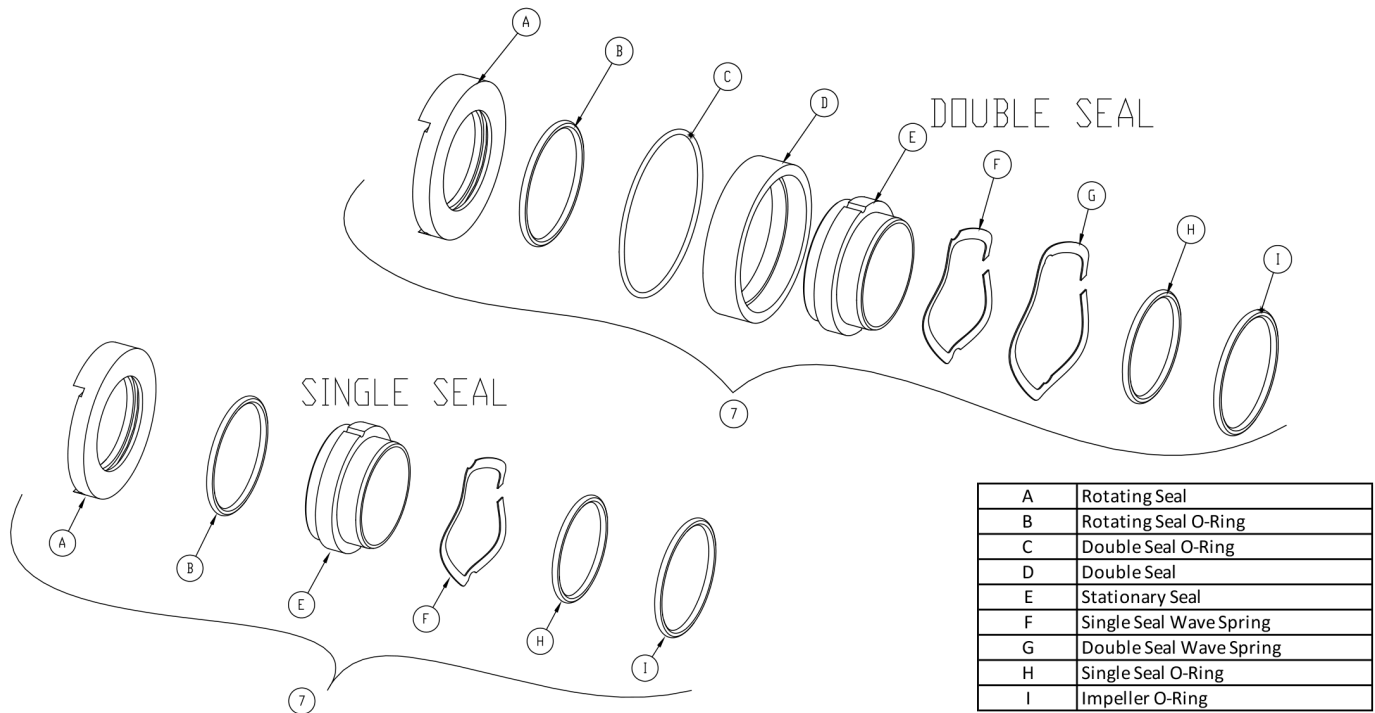

Exploded View - Seal Only

Optional Items Shown in ITALICS

Ref #	Component Item No.	Description	Qty Per
7	GS2600010-SC	KIT,SGL SEAL,C/N/V SP	1
	<i>GS2600010-SC</i>	<i>KIT,SGL SEAL,C/N/V SP</i>	<i>1</i>
	<i>GS2600018-SC</i>	<i>KIT,DBL SEAL,C/N/N/V SP</i>	<i>1</i>
	<i>GS2600020</i>	<i>KIT,DBL SEAL,C/C/N/V SP</i>	<i>1</i>

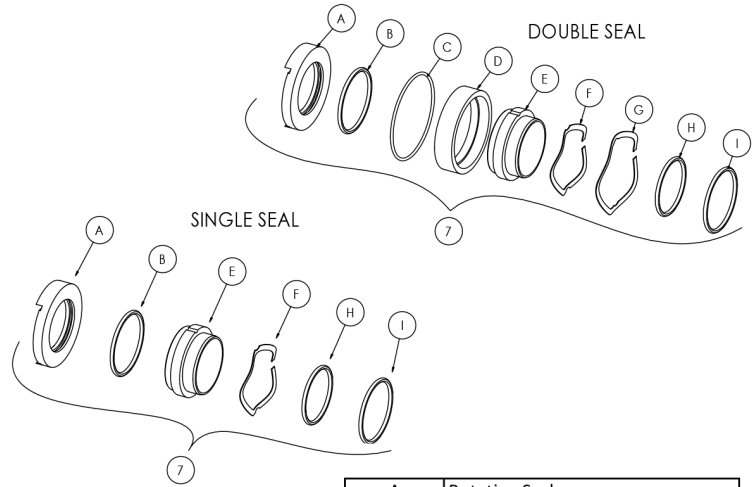
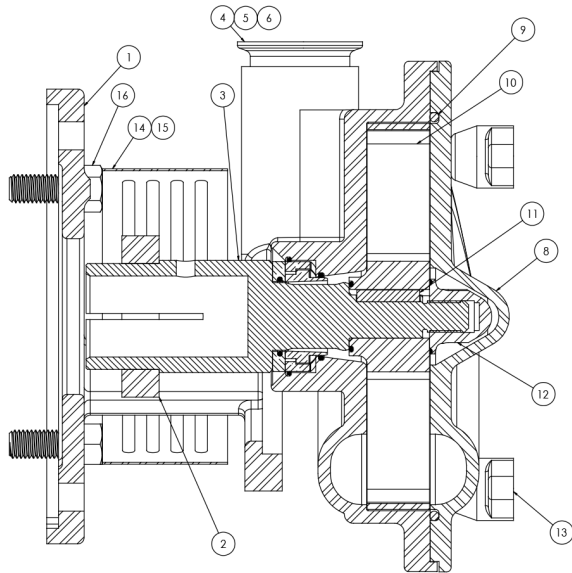

A	Rotating Seal
B	Rotating Seal O-Ring
C	Double Seal O-Ring
D	Double Seal
E	Stationary Seal
F	Single Seal Wave Spring
G	Double Seal Wave Spring
H	Single Seal O-Ring
I	Impeller O-Ring

Exploded View

Optional Items Shown in ITALICS

Ref #	Component Item No.	Description	Qty Per
1	SX10600097	ADAPTER,180-250TC FRAME SP	1
2	SX18000015	COLLAR,210TC,SHAFT LC	1
3	SX02000015	STUBSHAFT,210TC W/KEY SP	1
4	SV08610000	CASING,180-210TC,2 CLMP SP 210,215	1
5	GX10610400	CAPSCRW,HX,M12-1.75X30MM,18-8S HX HD	3
6	GX10610405	WASHER,LCK,1/2,18-8SS L SERIES	3
7	GS2600010-SC	KIT,SGL SEAL,C/N/V SP	1
	<i>GS2600010-SC</i>	<i>KIT,SGL SEAL,C/N/V SP</i>	<i>1</i>
	<i>GS2600018-SC</i>	<i>KIT,DBL SEAL,C/N/N/V SP</i>	<i>1</i>
	<i>GS2600020</i>	<i>KIT,DBL SEAL,C/C/N/V SP</i>	<i>1</i>
8	SC08620001	COVER,215,2 CLAMP SP	1
9	GX80000334	GASKET,210/215,CVR,BUNA SP	1
	<i>GX80000351</i>	<i>GASKET,210/215,CVR,EPDM SP</i>	<i>1</i>
	<i>GX80000335</i>	<i>GASKET,210/215,CVR,VITON SP</i>	<i>1</i>
10	SI08630000	IMPELLER,210/215 SP	1
11	SX15000018	KEY,210-220 SP	1
12	SI54000007	NUT,735,IMP,250TC-280TC	1
13	SX03000028	NUT,WING SP	3
14	SX10620036	GUARD,210-225,SHAFT SP	1
15	GX48104020	CAPSCRW,HX,1/4-28X3/8,18-8SS HX HD	2
16	SC1710H-SS	CAPSCRW,HX,1/2-13X1,18-8SS HX HD	4

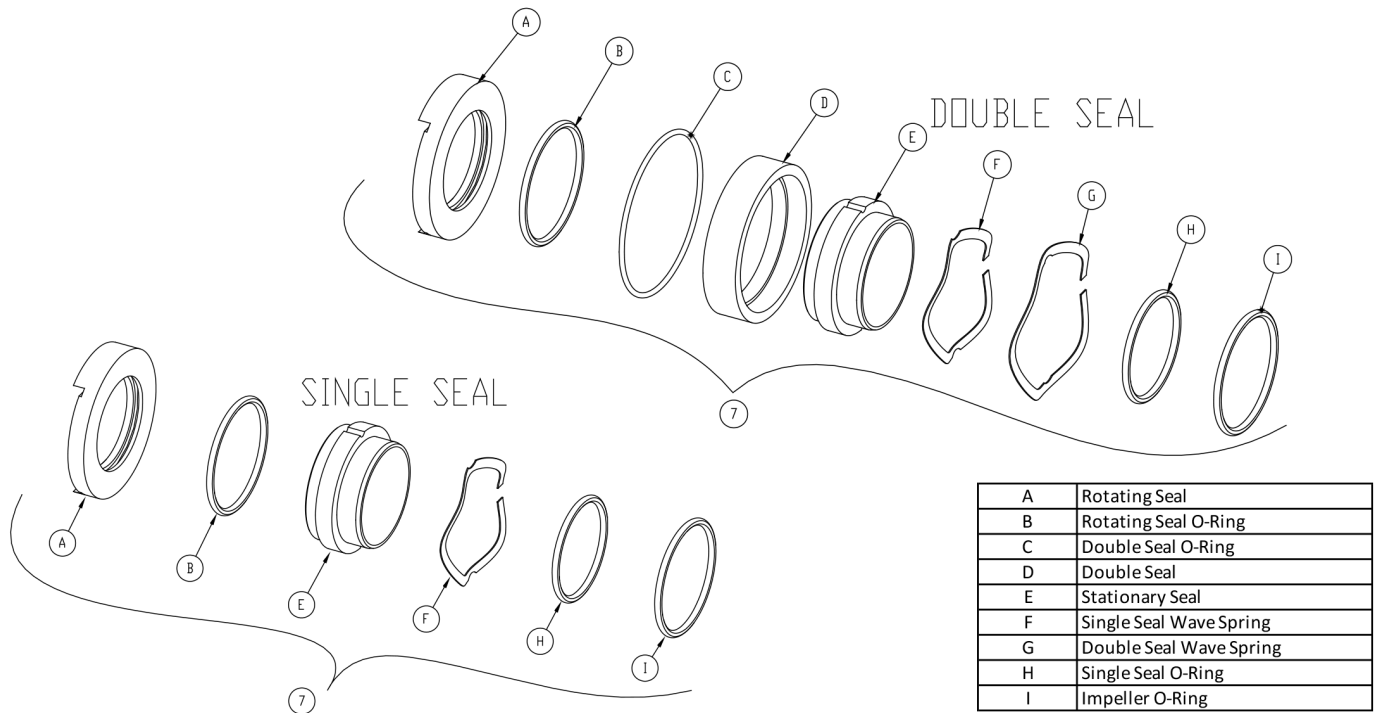

Exploded View - Seal Only

Optional Items Shown in ITALICS

Ref #	Component Item No.	Description	Qty Per
7	GS2600010-SC	KIT,SGL SEAL,C/N/V SP	1
	<i>GS2600010-SC</i>	<i>KIT,SGL SEAL,C/N/V SP</i>	<i>1</i>
	<i>GS2600018-SC</i>	<i>KIT,DBL SEAL,C/N/N/V SP</i>	<i>1</i>
	<i>GS2600020</i>	<i>KIT,DBL SEAL,C/C/N/V SP</i>	<i>1</i>

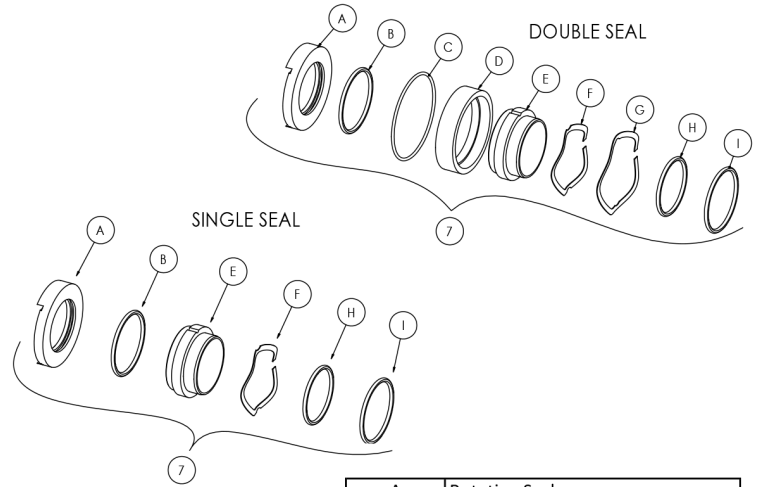
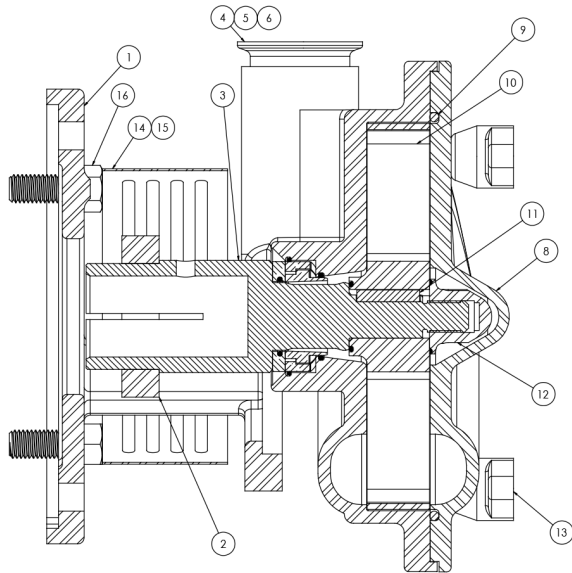

A	Rotating Seal
B	Rotating Seal O-Ring
C	Double Seal O-Ring
D	Double Seal
E	Stationary Seal
F	Single Seal Wave Spring
G	Double Seal Wave Spring
H	Single Seal O-Ring
I	Impeller O-Ring

Exploded View

Optional Items Shown in ITALICS

Ref #	Component Item No.	Description	Qty Per
1	SX10600897	ADAPTER,100/112 IEC FRAME SP	1
2	SX18000814	COLLAR,100/112 IEC,SHAFT,MTRIC	1
3	SX02000805	STUBSHAFT,100/112 IEC FRAME SP	1
4	SV08610000	CASING,180-210TC,2 CLMP SP 210,215	1
5	GX10610400	CAPSCRW,HX,M12-1.75X30MM,18-8S HX HD	3
6	GX10610405	WASHER,LCK,1/2,18-8SS L SERIES	3
7	GS2600010-SC	KIT,SGL SEAL,C/N/V SP	1
	<i>GS2600010-SC</i>	<i>KIT,SGL SEAL,C/N/V SP</i>	<i>1</i>
	<i>GS2600018-SC</i>	<i>KIT,DBL SEAL,C/N/N/V SP</i>	<i>1</i>
	<i>GS2600020</i>	<i>KIT,DBL SEAL,C/C/N/V SP</i>	<i>1</i>
8	SC08620001	COVER,215,2 CLAMP SP	1
9	GX80000334	GASKET,210/215,CVR,BUNA SP	1
	<i>GX80000351</i>	<i>GASKET,210/215,CVR,EPDM SP</i>	<i>1</i>
	<i>GX80000335</i>	<i>GASKET,210/215,CVR,VITON SP</i>	<i>1</i>
10	SI08630000	IMPELLER,210/215 SP	1
11	SX15000018	KEY,210-220 SP	1
12	SI54000007	NUT,735,IMP,250TC-280TC	1
13	SX03000020-ACRN	NUT,ACRN,R,M12-1.75.18-8SS L/SP SERIES	3
14	SX10620836	GUARD,100/215/220,SHAFT SP 100/112/132 IEC	1
15	GX48104021	SCREW,THUMB,1/4-28X3/8,304SS L SERIES	2
16	GX5516145	CAPSCRW,HX,M14-2.0X55MM,18-8SS HX HD	4
17	GX5516010	WASHER,LOCK,M14,18-8SS	4
	GX5516015	WASHER,FLAT,M14,18-8SS	8
18	GX5516000	NUT,HEX,M14-2.0,18-8SS HEX NUT	4

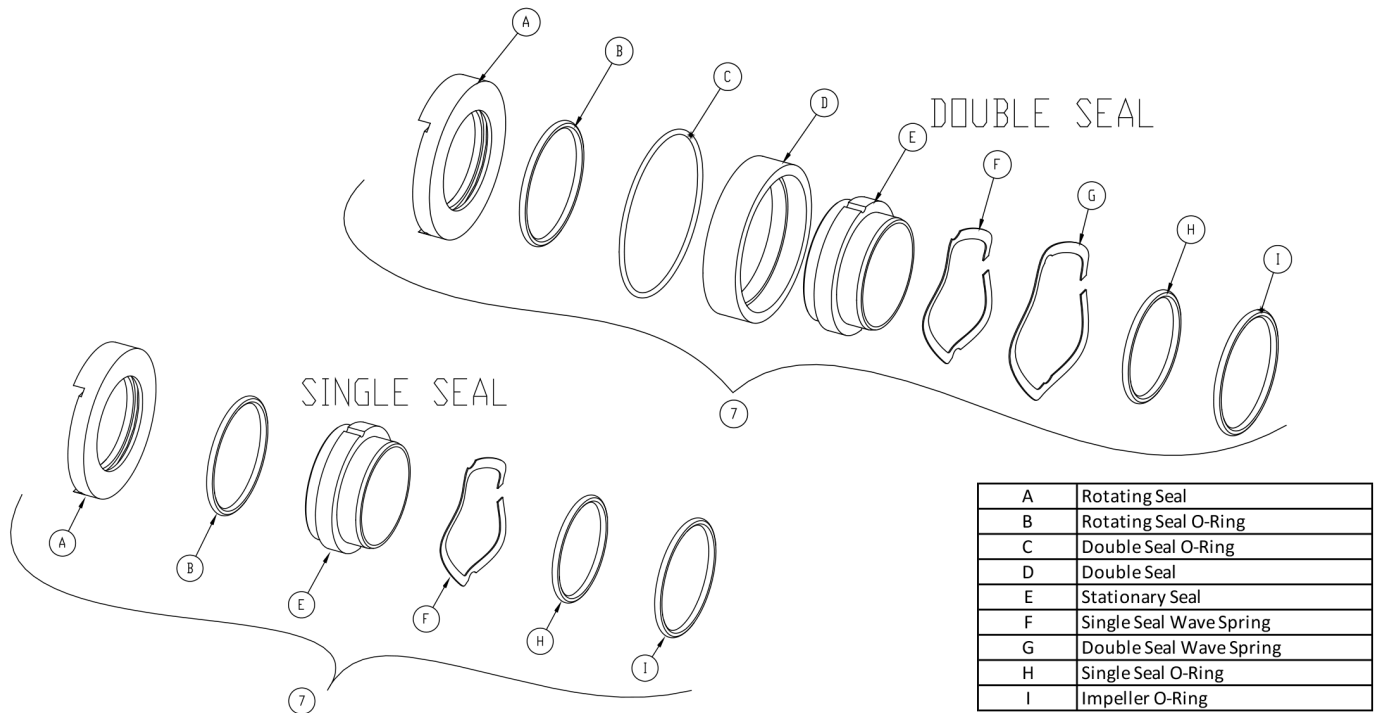

Exploded View - Seal Only

Optional Items Shown in ITALICS

Ref #	Component Item No.	Description	Qty Per
7	GS2600010-SC	KIT,SGL SEAL,C/N/V SP	1
	<i>GS2600010-SC</i>	<i>KIT,SGL SEAL,C/N/V SP</i>	<i>1</i>
	<i>GS2600018-SC</i>	<i>KIT,DBL SEAL,C/N/N/V SP</i>	<i>1</i>
	<i>GS2600020</i>	<i>KIT,DBL SEAL,C/C/N/V SP</i>	<i>1</i>

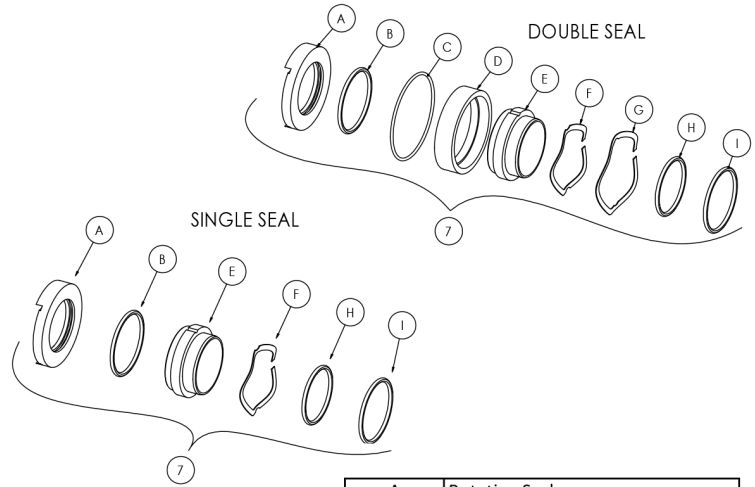
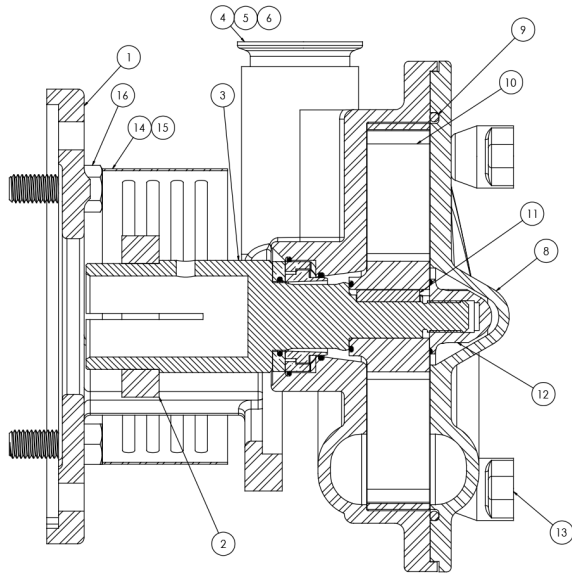

A	Rotating Seal
B	Rotating Seal O-Ring
C	Double Seal O-Ring
D	Double Seal
E	Stationary Seal
F	Single Seal Wave Spring
G	Double Seal Wave Spring
H	Single Seal O-Ring
I	Impeller O-Ring

Exploded View

Optional Items Shown in ITALICS

Ref #	Component Item No.	Description	Qty Per
1	SX10600898	ADAPTER,132 IEC FRAME SP	1
2	SX18000815	COLLAR,132 IEC,SHAFT,MTRIC	1
3	SX02000815	STUBSHAFT,132 IEC FRAME SP	1
4	SV08610000	CASING,180-210TC,2 CLMP SP 210,215	1
5	GX10610400	CAPSCRW,HX,M12-1.75X30MM,18-8S HX HD	3
6	GX10610405	WASHER,LCK,1/2,18-8SS L SERIES	3
7	GS2600010-SC	KIT,SGL SEAL,C/N/V SP	1
	<i>GS2600010-SC</i>	<i>KIT,SGL SEAL,C/N/V SP</i>	<i>1</i>
	<i>GS2600018-SC</i>	<i>KIT,DBL SEAL,C/N/N/V SP</i>	<i>1</i>
	<i>GS2600020</i>	<i>KIT,DBL SEAL,C/C/N/V SP</i>	<i>1</i>
8	SC08620001	COVER,215,2 CLAMP SP	1
9	GX80000334	GASKET,210/215,CVR,BUNA SP	1
	<i>GX80000351</i>	<i>GASKET,210/215,CVR,EPDM SP</i>	<i>1</i>
	<i>GX80000335</i>	<i>GASKET,210/215,CVR,VITON SP</i>	<i>1</i>
10	SI08630000	IMPELLER,210/215 SP	1
11	SX15000018	KEY,210-220 SP	1
12	SI54000007	NUT,735,IMP,250TC-280TC	1
13	SX03000020-ACRN	NUT,ACRN,R,M12-1.75.18-8SS L/SP SERIES	3
14	SX10620836	GUARD,100/215/220,SHAFT SP 100/112/132 IEC	1
15	GX48104021	SCREW,THUMB,1/4-28X3/8,304SS L SERIES	2
16	GX5516150	CAPSCRW,HX,M14-2.0X60MM,18-8SS HX HD	4
17	GX5516010	WASHER,LOCK,M14,18-8SS	4
	GX5516015	WASHER,FLAT,M14,18-8SS	8
18	GX5516000	NUT,HEX,M14-2.0,18-8SS HEX NUT	4

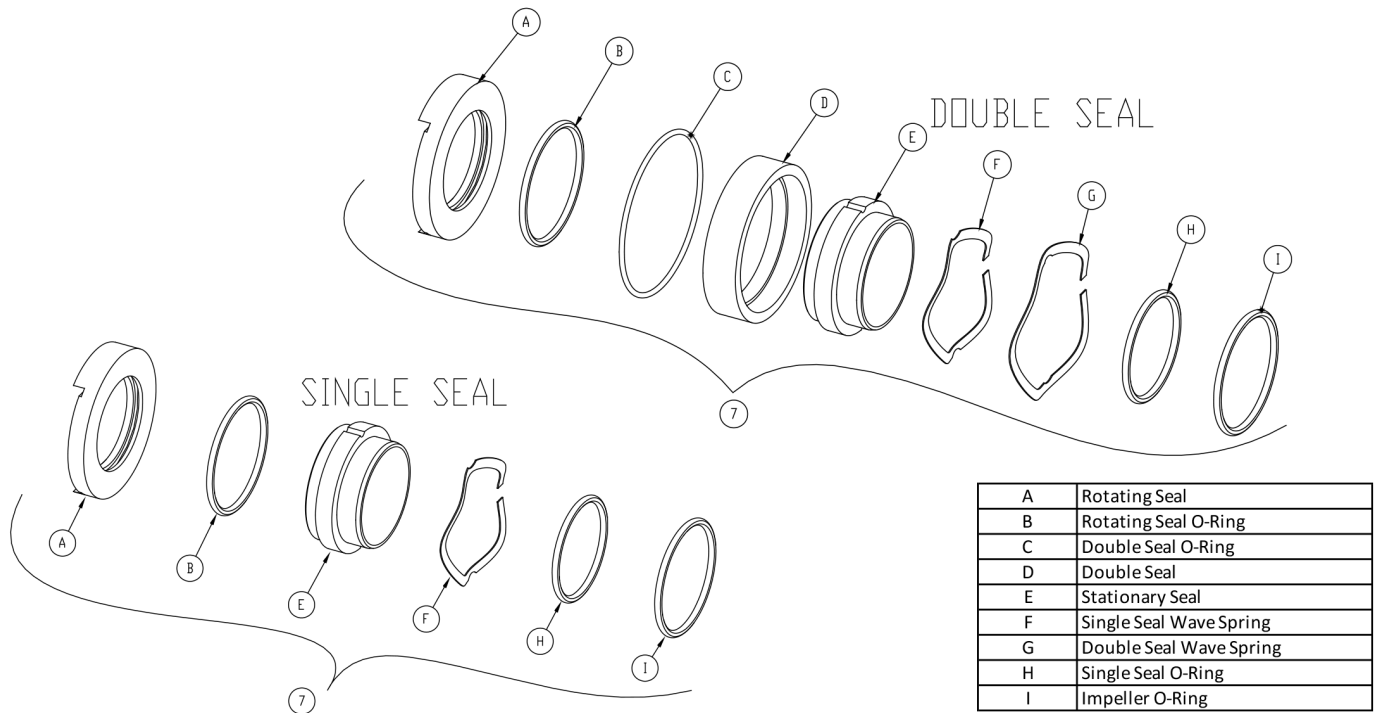

Exploded View - Seal Only

Optional Items Shown in ITALICS

Ref #	Component Item No.	Description	Qty Per
7	GS2600010-SC	KIT,SGL SEAL,C/N/V SP	1
	<i>GS2600010-SC</i>	<i>KIT,SGL SEAL,C/N/V SP</i>	<i>1</i>
	<i>GS2600018-SC</i>	<i>KIT,DBL SEAL,C/N/N/V SP</i>	<i>1</i>
	<i>GS2600020</i>	<i>KIT,DBL SEAL,C/C/N/V SP</i>	<i>1</i>

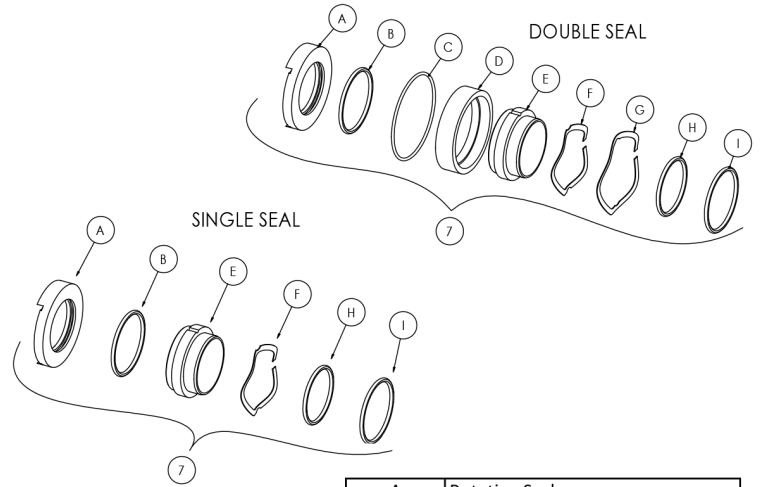
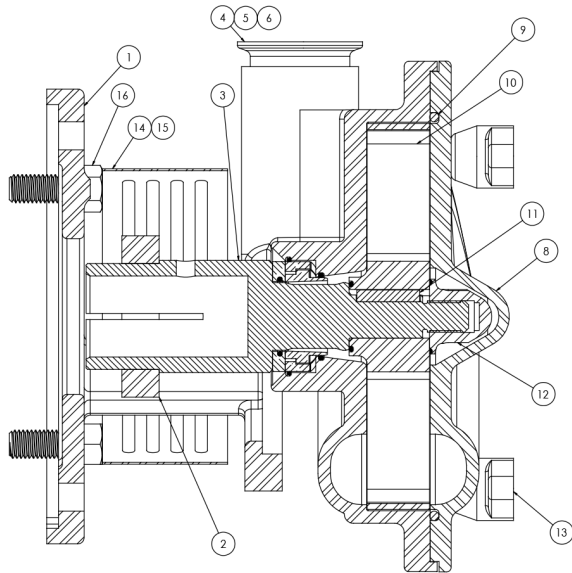

A	Rotating Seal
B	Rotating Seal O-Ring
C	Double Seal O-Ring
D	Double Seal
E	Stationary Seal
F	Single Seal Wave Spring
G	Double Seal Wave Spring
H	Single Seal O-Ring
I	Impeller O-Ring

Exploded View

Optional Items Shown in ITALICS

Ref #	Component Item No.	Description	Qty Per
1	SX10600097	ADAPTER,180-250TC FRAME SP	1
2	SX18000015	COLLAR,210TC,SHAFT LC	1
3	SX02000015	STUBSHAFT,210TC W/KEY SP	1
4	SV12610000	CASING,210-250TC,2 CLMP SP 220	1
5	GX10610400	CAPSCRW,HX,M12-1.75X30MM,18-8S HX HD	3
6	GX10610405	WASHER,LCK,1/2,18-8SS L SERIES	3
7	GS2600010-SC	KIT,SGL SEAL,C/N/V SP	1
	<i>GS2600010-SC</i>	<i>KIT,SGL SEAL,C/N/V SP</i>	<i>1</i>
	<i>GS2600018-SC</i>	<i>KIT,DBL SEAL,C/N/N/V SP</i>	<i>1</i>
	<i>GS2600020</i>	<i>KIT,DBL SEAL,C/C/N/V SP</i>	<i>1</i>
8	SC12620000	COVER,220,2 CLAMP SP	1
9	GX80000336	GASKET,220,CVR,BUNA SP	1
	<i>GX80000058</i>	<i>GASKET,220,CVR,EPDM SP</i>	<i>1</i>
	<i>GX80000019</i>	<i>GASKET,220,CVR,VITON SP</i>	<i>1</i>
10	SI12630000	IMPELLER,220 SP	1
11	SX15000018	KEY,210-220 SP	1
12	SI54000007	NUT,735,IMP,250TC-280TC	1
13	SX03000028	NUT,WING SP	4
14	SX10620036	GUARD,210-225,SHAFT SP	1
15	GX48104020	CAPSCRW,HX,1/4-28X3/8,18-8SS HX HD	2
16	SC1710H-SS	CAPSCRW,HX,1/2-13X1,18-8SS HX HD	4

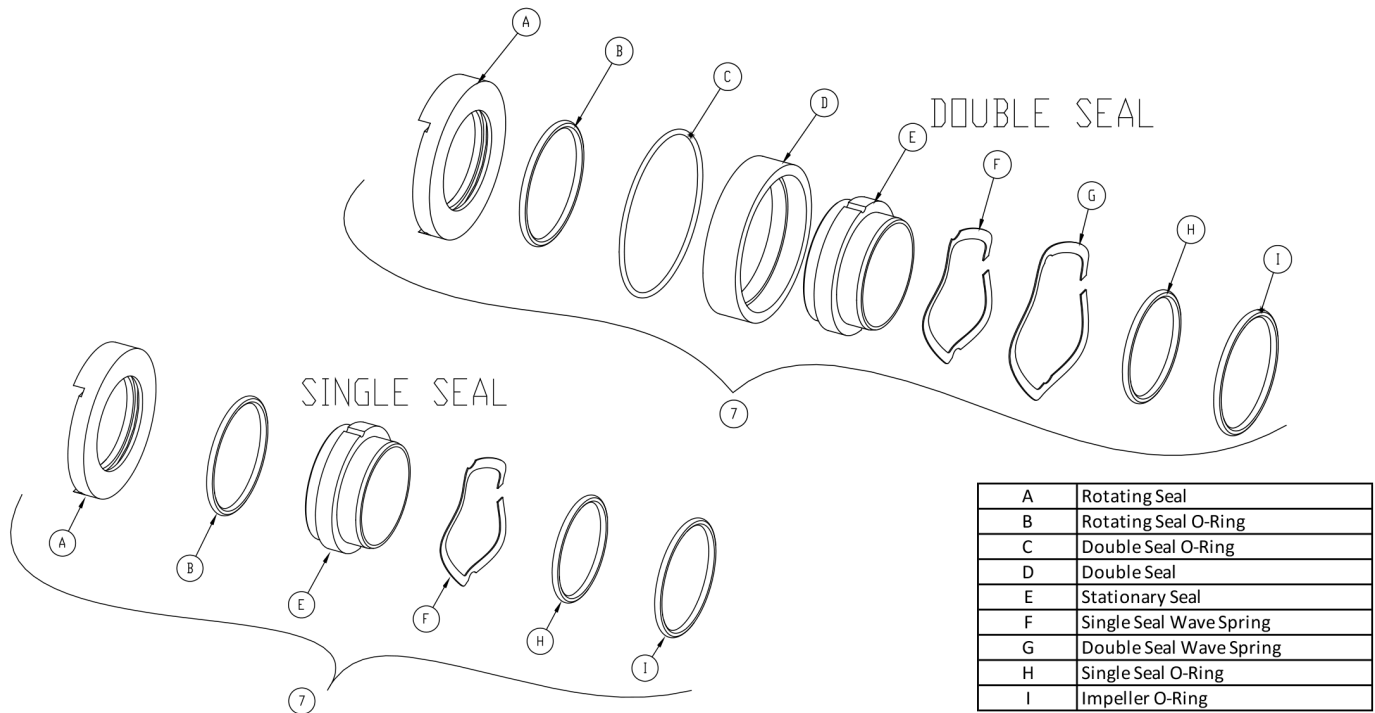

Exploded View - Seal Only

Optional Items Shown in ITALICS

Ref #	Component Item No.	Description	Qty Per
7	GS2600010-SC	KIT,SGL SEAL,C/N/V SP	1
	<i>GS2600010-SC</i>	<i>KIT,SGL SEAL,C/N/V SP</i>	<i>1</i>
	<i>GS2600018-SC</i>	<i>KIT,DBL SEAL,C/N/N/V SP</i>	<i>1</i>
	<i>GS2600020</i>	<i>KIT,DBL SEAL,C/C/N/V SP</i>	<i>1</i>

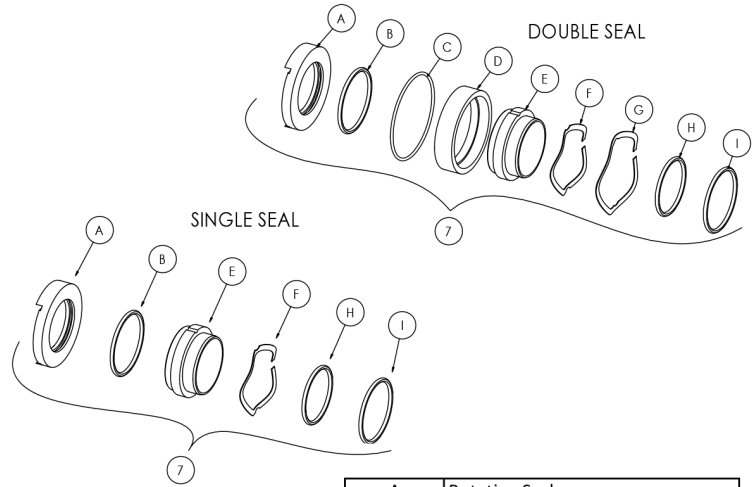
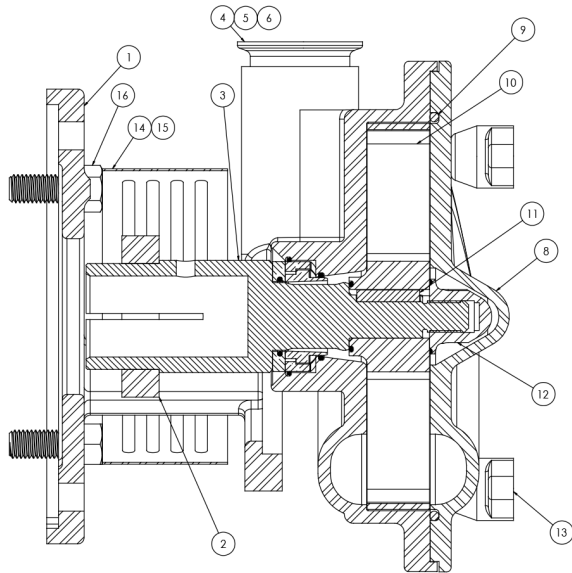

A	Rotating Seal
B	Rotating Seal O-Ring
C	Double Seal O-Ring
D	Double Seal
E	Stationary Seal
F	Single Seal Wave Spring
G	Double Seal Wave Spring
H	Single Seal O-Ring
I	Impeller O-Ring

Exploded View

Optional Items Shown in ITALICS

Ref #	Component Item No.	Description	Qty Per
1	SX10600097	ADAPTER,180-250TC FRAME SP	1
2	SX18000016	COLLAR,250TC/280TSC,SHAFT LC	1
3	SX02000023	STUBSHAFT,250TC W/KEY SP	1
4	SV12610000	CASING,210-250TC,2 CLMP SP 220	1
5	GX10610400	CAPSCRW,HX,M12-1.75X30MM,18-8S HX HD	3
6	GX10610405	WASHER,LCK,1/2,18-8SS L SERIES	3
7	GS2600010-SC	KIT,SGL SEAL,C/N/V SP	1
	<i>GS2600010-SC</i>	<i>KIT,SGL SEAL,C/N/V SP</i>	<i>1</i>
	<i>GS2600018-SC</i>	<i>KIT,DBL SEAL,C/N/N/V SP</i>	<i>1</i>
	<i>GS2600020</i>	<i>KIT,DBL SEAL,C/C/N/V SP</i>	<i>1</i>
8	SC12620000	COVER,220,2 CLAMP SP	1
9	GX80000336	GASKET,220,CVR,BUNA SP	1
	<i>GX80000058</i>	<i>GASKET,220,CVR,EPDM SP</i>	<i>1</i>
	<i>GX80000019</i>	<i>GASKET,220,CVR,VITON SP</i>	<i>1</i>
10	SI12630000	IMPELLER,220 SP	1
11	SX15000018	KEY,210-220 SP	1
12	SI54000007	NUT,735,IMP,250TC-280TC	1
13	SX03000028	NUT,WING SP	4
14	SX10620036	GUARD,210-225,SHAFT SP	1
15	GX48104020	CAPSCRW,HX,1/4-28X3/8,18-8SS HX HD	2
16	SC1710H-SS	CAPSCRW,HX,1/2-13X1,18-8SS HX HD	4

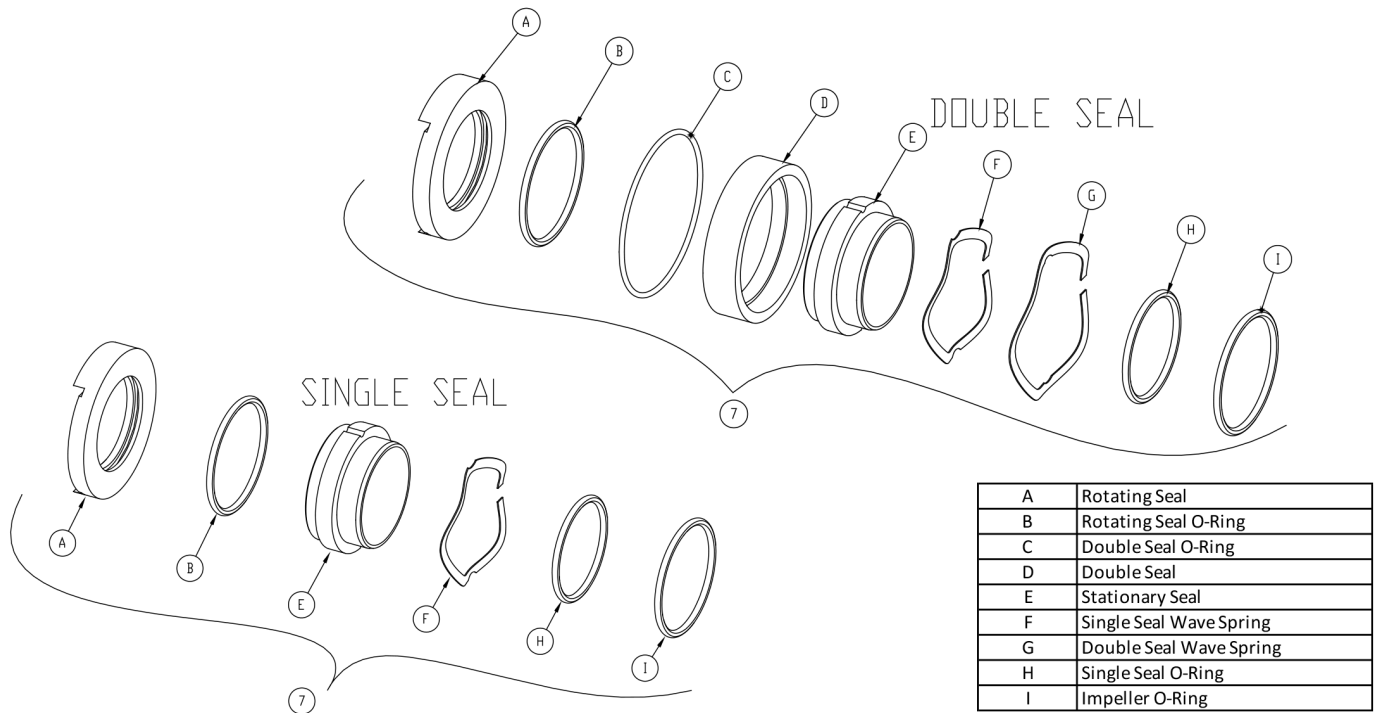

A	Rotating Seal
B	Rotating Seal O-Ring
C	Double Seal O-Ring
D	Double Seal
E	Stationary Seal
F	Single Seal Wave Spring
G	Double Seal Wave Spring
H	Single Seal O-Ring
I	Impeller O-Ring

Exploded View - Seal Only

Optional Items Shown in ITALICS

Ref #	Component Item No.	Description	Qty Per
7	GS2600010-SC	KIT,SGL SEAL,C/N/V SP	1
	<i>GS2600010-SC</i>	<i>KIT,SGL SEAL,C/N/V SP</i>	<i>1</i>
	<i>GS2600018-SC</i>	<i>KIT,DBL SEAL,C/N/N/V SP</i>	<i>1</i>
	<i>GS2600020</i>	<i>KIT,DBL SEAL,C/C/N/V SP</i>	<i>1</i>

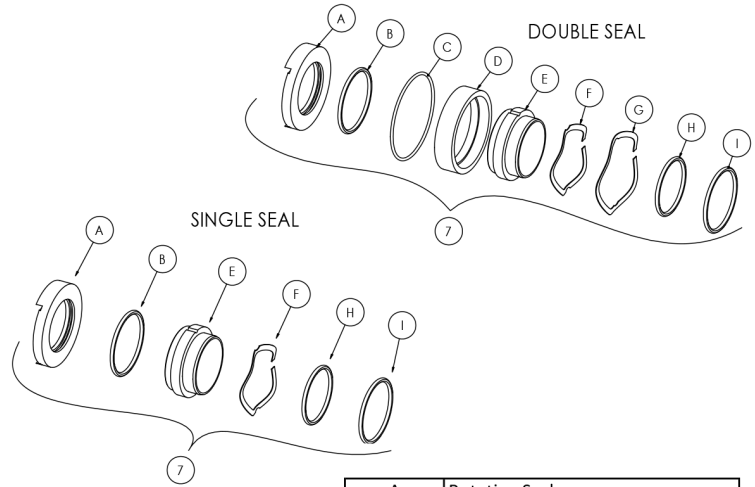
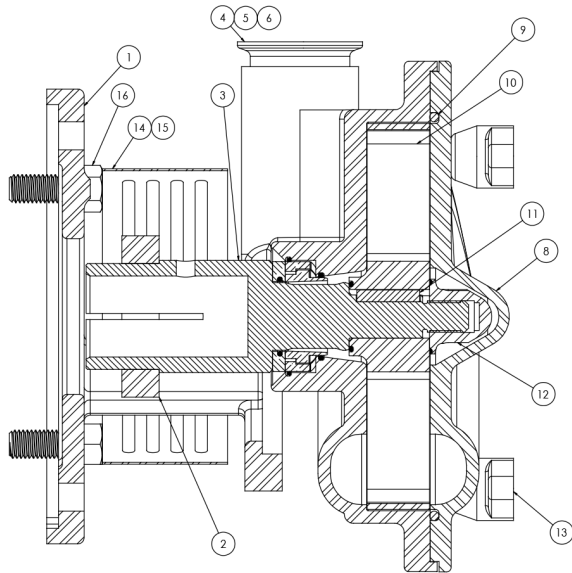

A	Rotating Seal
B	Rotating Seal O-Ring
C	Double Seal O-Ring
D	Double Seal
E	Stationary Seal
F	Single Seal Wave Spring
G	Double Seal Wave Spring
H	Single Seal O-Ring
I	Impeller O-Ring

Exploded View

Optional Items Shown in ITALICS

Ref #	Component Item No.	Description	Qty Per
1	SX10600897	ADAPTER,100/112 IEC FRAME SP	1
2	SX18000814	COLLAR,100/112 IEC,SHAFT,MTRIC	1
3	SX02000805	STUBSHAFT,100/112 IEC FRAME SP	1
4	SV12610000	CASING,210-250TC,2 CLMP SP 220	1
5	GX10610400	CAPSCRW,HX,M12-1.75X30MM,18-8S HX HD	3
6	GX10610405	WASHER,LCK,1/2,18-8SS L SERIES	3
7	GS2600010-SC	KIT,SGL SEAL,C/N/V SP	1
	<i>GS2600010-SC</i>	<i>KIT,SGL SEAL,C/N/V SP</i>	<i>1</i>
	<i>GS2600018-SC</i>	<i>KIT,DBL SEAL,C/N/N/V SP</i>	<i>1</i>
	<i>GS2600020</i>	<i>KIT,DBL SEAL,C/C/N/V SP</i>	<i>1</i>
8	SC12620000	COVER,220,2 CLAMP SP	1
9	GX80000336	GASKET,220,CVR,BUNA SP	1
	<i>GX80000058</i>	<i>GASKET,220,CVR,EPDM SP</i>	<i>1</i>
	<i>GX80000019</i>	<i>GASKET,220,CVR,VITON SP</i>	<i>1</i>
10	SI12630000	IMPELLER,220 SP	1
11	SX15000018	KEY,210-220 SP	1
12	SI54000007	NUT,735,IMP,250TC-280TC	1
13	SX03000020-ACRN	NUT,ACRN,R,M12-1.75.18-8SS L/SP SERIES	4
14	SX10620836	GUARD,100/215/220,SHAFT SP 100/112/132 IEC	1
15	GX48104021	SCREW,THUMB,1/4-28X3/8,304SS L SERIES	2
16	GX5516145	CAPSCRW,HX,M14-2.0X55MM,18-8SS HX HD	4
17	GX5516010	WASHER,LOCK,M14,18-8SS	4
	GX5516015	WASHER,FLAT,M14,18-8SS	8
18	GX5516000	NUT,HEX,M14-2.0,18-8SS HEX NUT	4

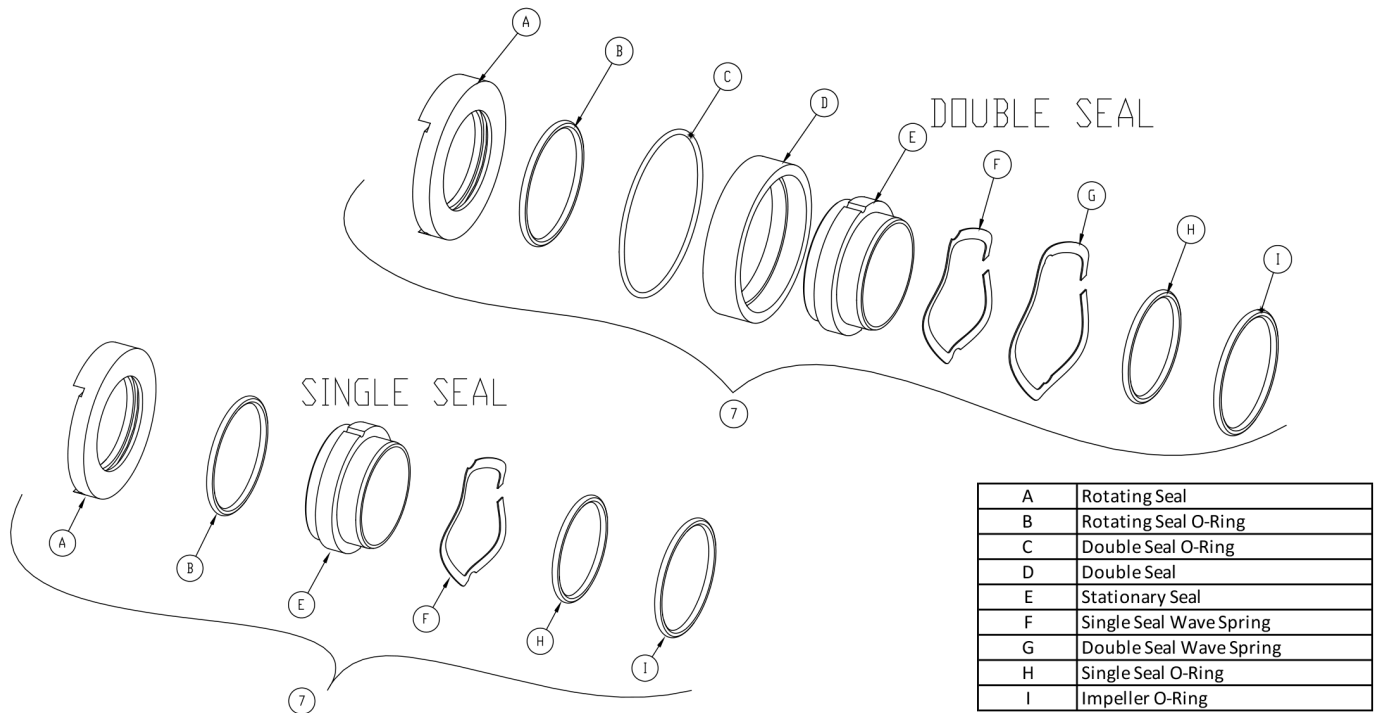

Exploded View - Seal Only

Optional Items Shown in ITALICS

Ref #	Component Item No.	Description	Qty Per
7	GS2600010-SC	KIT,SGL SEAL,C/N/V SP	1
	<i>GS2600010-SC</i>	<i>KIT,SGL SEAL,C/N/V SP</i>	<i>1</i>
	<i>GS2600018-SC</i>	<i>KIT,DBL SEAL,C/N/N/V SP</i>	<i>1</i>
	<i>GS2600020</i>	<i>KIT,DBL SEAL,C/C/N/V SP</i>	<i>1</i>

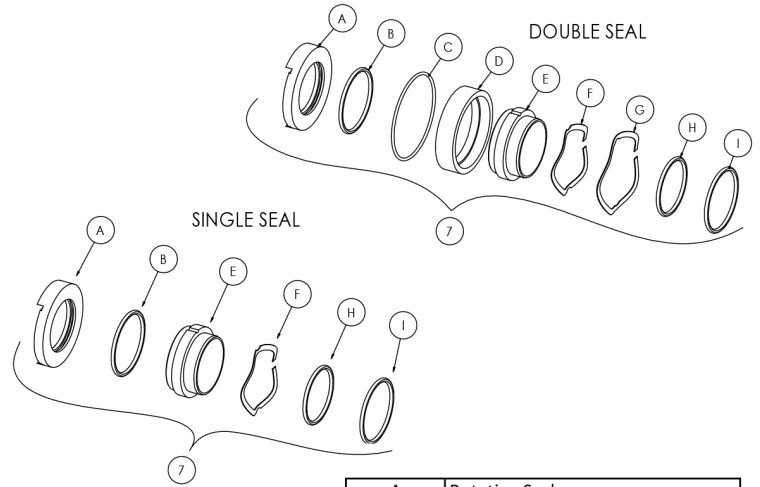
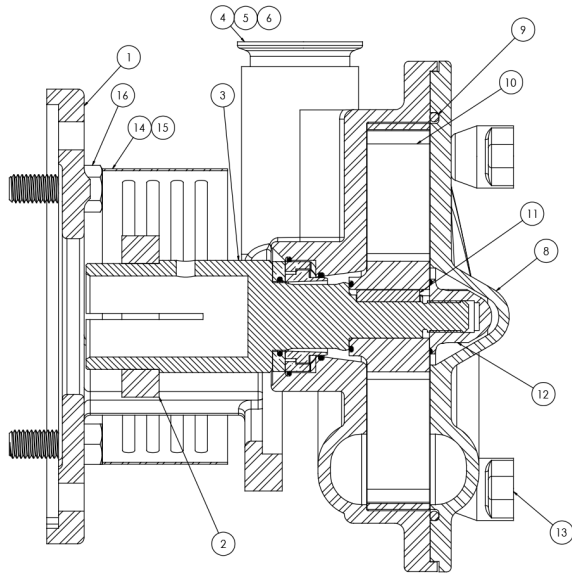

A	Rotating Seal
B	Rotating Seal O-Ring
C	Double Seal O-Ring
D	Double Seal
E	Stationary Seal
F	Single Seal Wave Spring
G	Double Seal Wave Spring
H	Single Seal O-Ring
I	Impeller O-Ring

Exploded View

Optional Items Shown in ITALICS

Ref #	Component Item No.	Description	Qty Per
1	SX10600898	ADAPTER,132 IEC FRAME SP	1
2	SX18000815	COLLAR,132 IEC,SHAFT,MTRIC	1
3	SX02000815	STUBSHAFT,132 IEC FRAME SP	1
4	SV12610000	CASING,210-250TC,2 CLMP SP 220	1
5	GX10610400	CAPSCRW,HX,M12-1.75X30MM,18-8S HX HD	3
6	GX10610405	WASHER,LCK,1/2,18-8SS L SERIES	3
7	GS2600010-SC	KIT,SGL SEAL,C/N/V SP	1
	<i>GS2600010-SC</i>	<i>KIT,SGL SEAL,C/N/V SP</i>	<i>1</i>
	<i>GS2600018-SC</i>	<i>KIT,DBL SEAL,C/N/N/V SP</i>	<i>1</i>
	<i>GS2600020</i>	<i>KIT,DBL SEAL,C/C/N/V SP</i>	<i>1</i>
8	SC12620000	COVER,220,2 CLAMP SP	1
9	GX80000336	GASKET,220,CVR,BUNA SP	1
	<i>GX80000058</i>	<i>GASKET,220,CVR,EPDM SP</i>	<i>1</i>
	<i>GX80000019</i>	<i>GASKET,220,CVR,VITON SP</i>	<i>1</i>
10	SI12630000	IMPELLER,220 SP	1
11	SX15000018	KEY,210-220 SP	1
12	SI54000007	NUT,735,IMP,250TC-280TC	1
13	SX03000020-ACRN	NUT,ACRN,R,M12-1.75.18-8SS L/SP SERIES	4
14	SX10620836	GUARD,100/215/220,SHAFT SP 100/112/132 IEC	1
15	GX48104021	SCREW,THUMB,1/4-28X3/8,304SS L SERIES	2
16	GX5516150	CAPSCRW,HX,M14-2.0X60MM,18-8SS HX HD	4
17	GX5516010	WASHER,LOCK,M14,18-8SS	4
	GX5516015	WASHER,FLAT,M14,18-8SS	8
18	GX5516000	NUT,HEX,M14-2.0,18-8SS HEX NUT	4

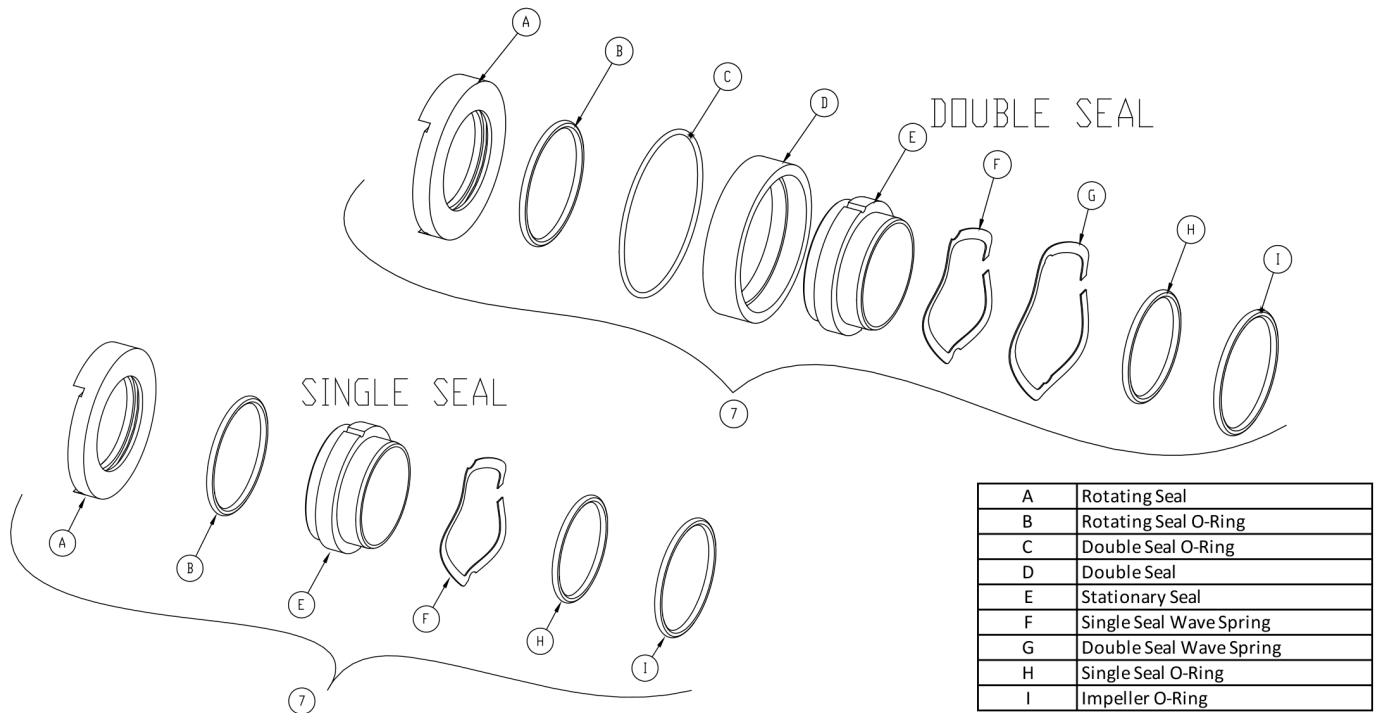

A	Rotating Seal
B	Rotating Seal O-Ring
C	Double Seal O-Ring
D	Double Seal
E	Stationary Seal
F	Single Seal Wave Spring
G	Double Seal Wave Spring
H	Single Seal O-Ring
I	Impeller O-Ring

Exploded View - Seal Only

Optional Items Shown in ITALICS

Ref #	Component Item No.	Description	Qty Per
7	GS2600010-SC	KIT,SGL SEAL,C/N/V SP	1
	<i>GS2600010-SC</i>	<i>KIT,SGL SEAL,C/N/V SP</i>	<i>1</i>
	<i>GS2600018-SC</i>	<i>KIT,DBL SEAL,C/N/N/V SP</i>	<i>1</i>
	<i>GS2600020</i>	<i>KIT,DBL SEAL,C/C/N/V SP</i>	<i>1</i>

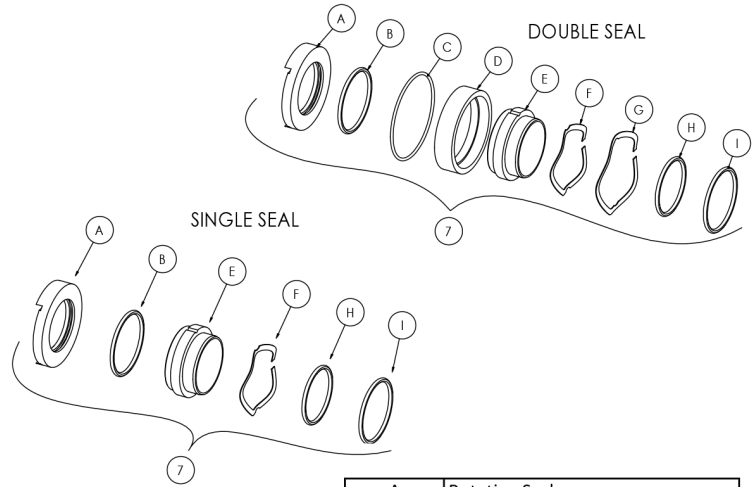
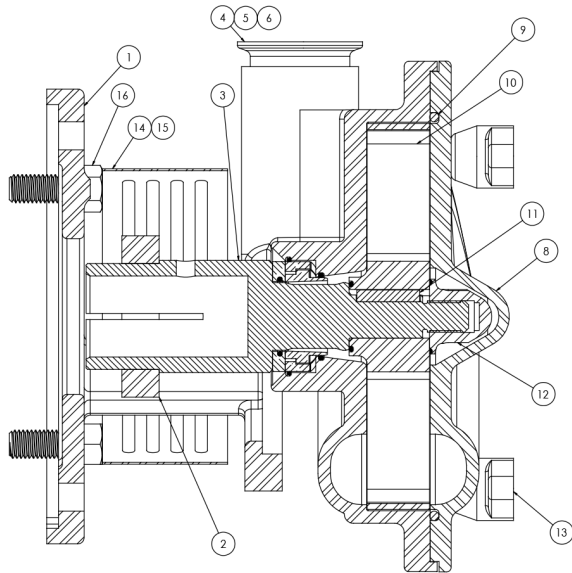

A	Rotating Seal
B	Rotating Seal O-Ring
C	Double Seal O-Ring
D	Double Seal
E	Stationary Seal
F	Single Seal Wave Spring
G	Double Seal Wave Spring
H	Single Seal O-Ring
I	Impeller O-Ring

Exploded View

Optional Items Shown in ITALICS

Ref #	Component Item No.	Description	Qty Per
1	SX10600899	ADAPTER,160 IEC FRAME SP	1
2	SX18000816	COLLAR,160,IEC,SHAFT,MTRIC	1
3	SX02000823	STUBSHAFT,160 IEC FRAME SP	1
4	SV12610000	CASING,210-250TC,2 CLMP SP 220	1
5	GX10610400	CAPSCRW,HX,M12-1.75X30MM,18-8S HX HD	3
6	GX10610405	WASHER,LCK,1/2,18-8SS L SERIES	3
7	GS2600010-SC	KIT,SGL SEAL,C/N/V SP	1
	<i>GS2600010-SC</i>	<i>KIT,SGL SEAL,C/N/V SP</i>	<i>1</i>
	<i>GS2600018-SC</i>	<i>KIT,DBL SEAL,C/N/N/V SP</i>	<i>1</i>
	<i>GS2600020</i>	<i>KIT,DBL SEAL,C/C/N/V SP</i>	<i>1</i>
8	SC12620000	COVER,220,2 CLAMP SP	1
9	GX80000336	GASKET,220,CVR,BUNA SP	1
	<i>GX80000058</i>	<i>GASKET,220,CVR,EPDM SP</i>	<i>1</i>
	<i>GX80000019</i>	<i>GASKET,220,CVR,VITON SP</i>	<i>1</i>
10	SI12630000	IMPELLER,220 SP	1
11	SX15000018	KEY,210-220 SP	1
12	SI54000007	NUT,735,IMP,250TC-280TC	1
13	SX03000020-ACRN	NUT,ACRN,R,M12-1.75.18-8SS L/SP SERIES	4
14	SX10620837	GUARD,225,SHAFT,160IEC SP	1
15	GX48104021	SCREW,THUMB,1/4-28X3/8,304SS L SERIES	2
16	GX5518170	CAPSCRW,HX,M18-2.5X70MM,18-8SS HX HD	4
17	GX5518010	WASHER,LOCK,M18,18-8SS	4
	GX5518015	WASHER,FLAT,M18,18-8SS	8
18	GX5518000	NUT,HEX,M18-2.5,18-8SS HEX NUT	4

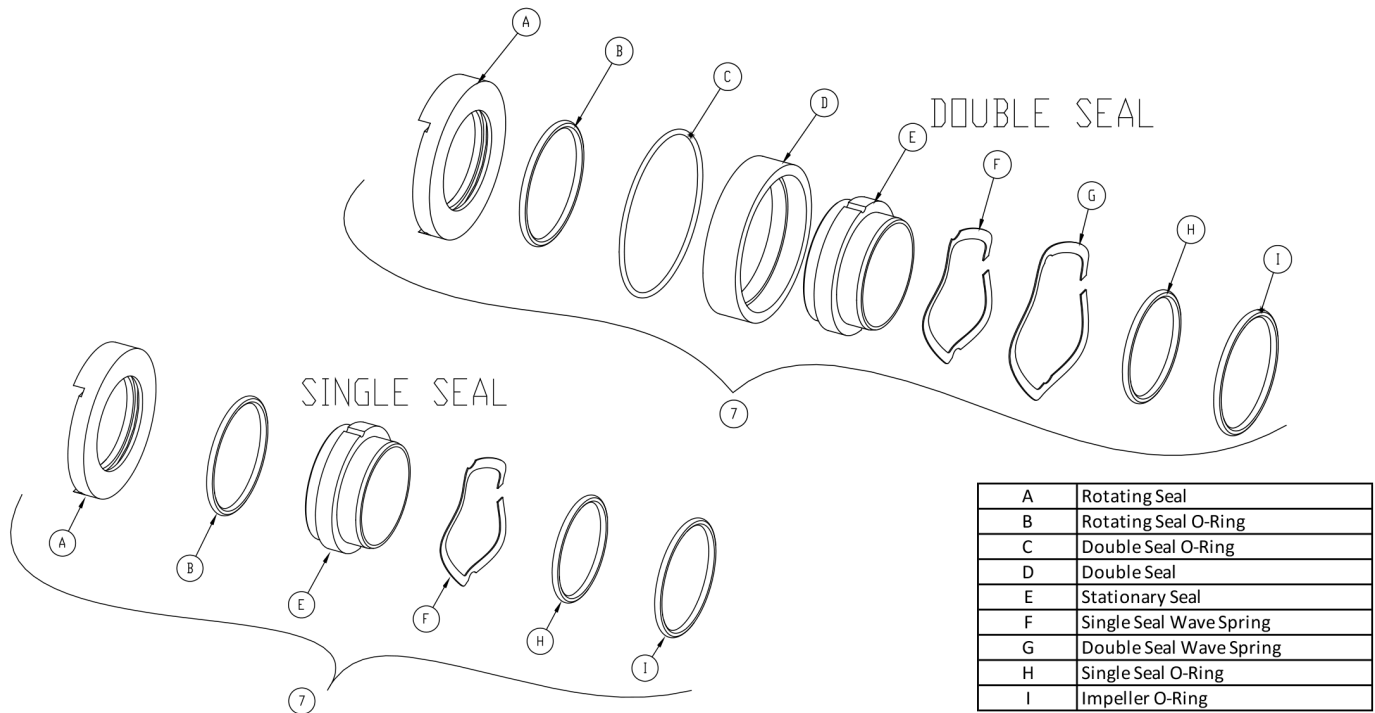

A	Rotating Seal
B	Rotating Seal O-Ring
C	Double Seal O-Ring
D	Double Seal
E	Stationary Seal
F	Single Seal Wave Spring
G	Double Seal Wave Spring
H	Single Seal O-Ring
I	Impeller O-Ring

Exploded View - Seal Only

Optional Items Shown in ITALICS

Ref #	Component Item No.	Description	Qty Per
7	GS2600010-SC	KIT,SGL SEAL,C/N/V SP	1
	<i>GS2600010-SC</i>	<i>KIT,SGL SEAL,C/N/V SP</i>	<i>1</i>
	<i>GS2600018-SC</i>	<i>KIT,DBL SEAL,C/N/N/V SP</i>	<i>1</i>
	<i>GS2600020</i>	<i>KIT,DBL SEAL,C/C/N/V SP</i>	<i>1</i>

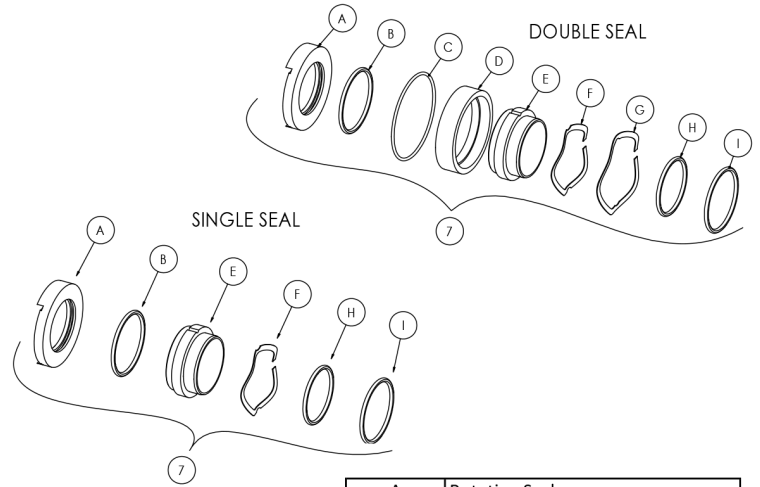
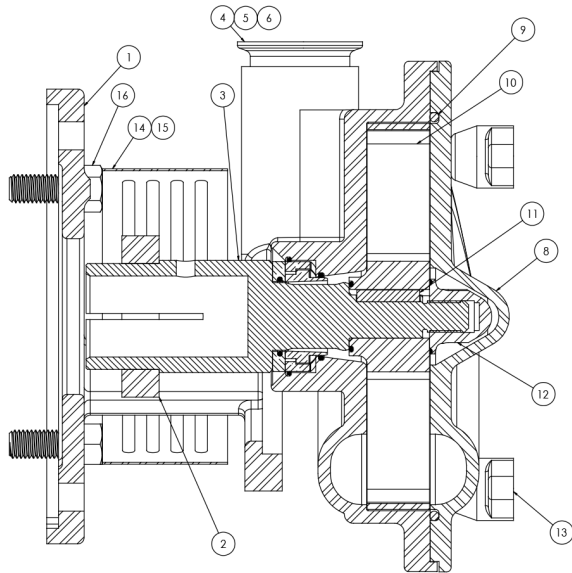

A	Rotating Seal
B	Rotating Seal O-Ring
C	Double Seal O-Ring
D	Double Seal
E	Stationary Seal
F	Single Seal Wave Spring
G	Double Seal Wave Spring
H	Single Seal O-Ring
I	Impeller O-Ring

Exploded View

Optional Items Shown in ITALICS

Ref #	Component Item No.	Description	Qty Per
1	SX10600097	ADAPTER,180-250TC FRAME SP	1
2	SX18000015	COLLAR,210TC,SHAFT LC	1
3	SX02000015	STUBSHAFT,210TC W/KEY SP	1
4	SV14610000-SP	CASING,210-250TC,2-1/2 CLMP SP 225	1
5	GX10610400	CAPSCRW,HX,M12-1.75X30MM,18-8S HX HD	3
6	GX10610405	WASHER,LCK,1/2,18-8SS L SERIES	3
7	GS2600010-SC	KIT,SGL SEAL,C/N/V SP	1
	<i>GS2600010-SC</i>	<i>KIT,SGL SEAL,C/N/V SP</i>	<i>1</i>
	<i>GS2600018-SC</i>	<i>KIT,DBL SEAL,C/N/N/V SP</i>	<i>1</i>
	<i>GS2600020</i>	<i>KIT,DBL SEAL,C/C/N/V SP</i>	<i>1</i>
8	SC14620000	COVER,225,2-1/2 CLAMP SP	1
9	GX80000363	GASKET,225,CVR,BUNA SP	1
	<i>GX80000361</i>	<i>GASKET,225,CVR,EPDM SP</i>	<i>1</i>
	<i>GX80000362</i>	<i>GASKET,225,CVR,VIT SP</i>	<i>1</i>
10	SI14630000	IMPELLER,225 SP	1
11	SX15000018	KEY,210-220 SP	1
12	SI54000007	NUT,735,IMP,250TC-280TC	1
13	SX03000028	NUT,WING SP	5
14	SX10620036	GUARD,210-225,SHAFT SP	1
15	GX48104020	CAPSCRW,HX,1/4-28X3/8,18-8SS HX HD	2
16	SC1710H-SS	CAPSCRW,HX,1/2-13X1,18-8SS HX HD	4

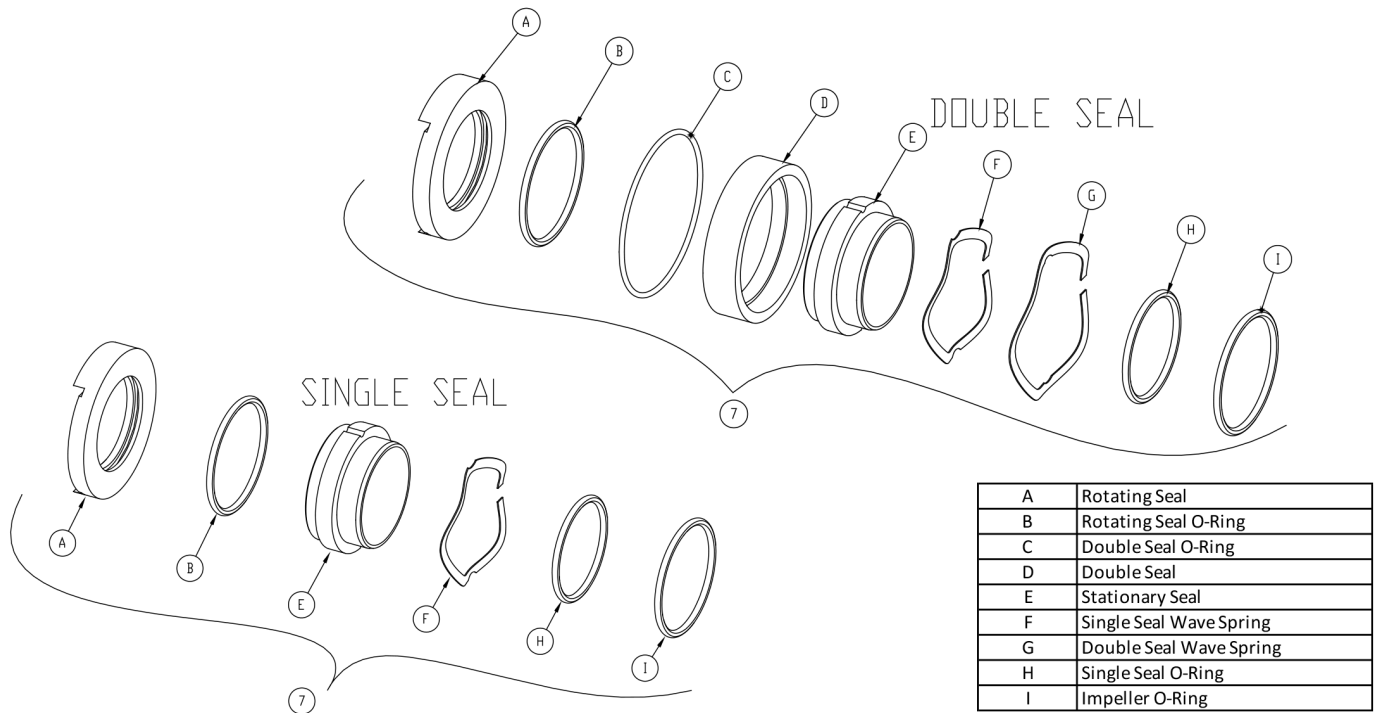

Exploded View - Seal Only

Optional Items Shown in ITALICS

Ref #	Component Item No.	Description	Qty Per
7	GS2600010-SC	KIT,SGL SEAL,C/N/V SP	1
	<i>GS2600010-SC</i>	<i>KIT,SGL SEAL,C/N/V SP</i>	<i>1</i>
	<i>GS2600018-SC</i>	<i>KIT,DBL SEAL,C/N/N/V SP</i>	<i>1</i>
	<i>GS2600020</i>	<i>KIT,DBL SEAL,C/C/N/V SP</i>	<i>1</i>

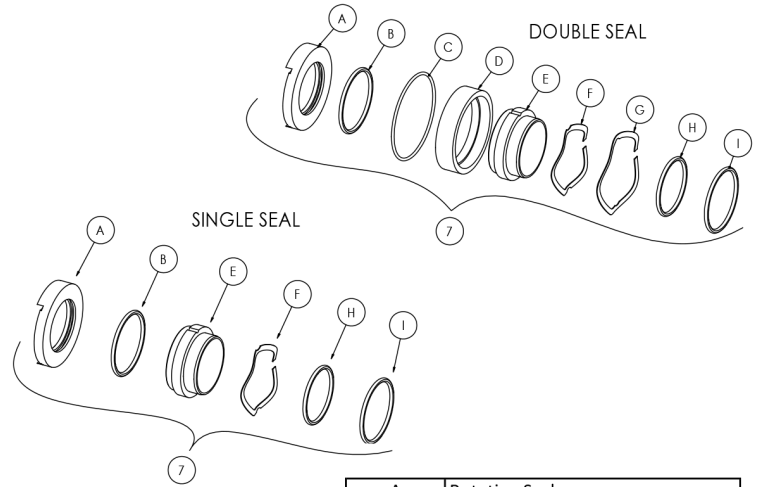
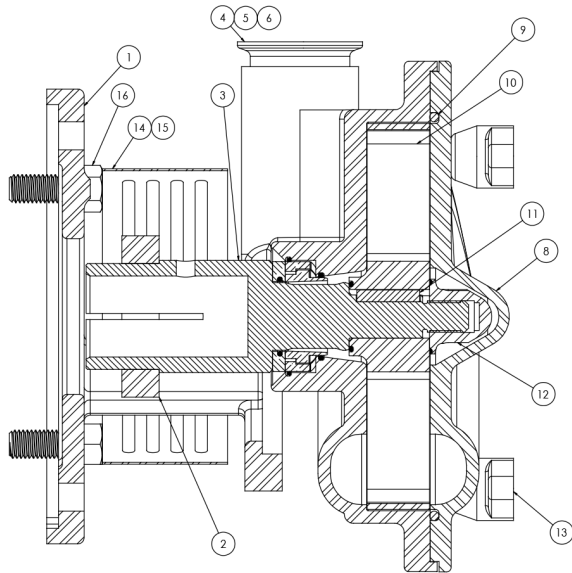

A	Rotating Seal
B	Rotating Seal O-Ring
C	Double Seal O-Ring
D	Double Seal
E	Stationary Seal
F	Single Seal Wave Spring
G	Double Seal Wave Spring
H	Single Seal O-Ring
I	Impeller O-Ring

Exploded View

Optional Items Shown in ITALICS

Ref #	Component Item No.	Description	Qty Per
1	SX10600097	ADAPTER,180-250TC FRAME SP	1
2	SX18000016	COLLAR,250TC/280TSC,SHAFT LC	1
3	SX02000023	STUBSHAFT,250TC W/KEY SP	1
4	SV14610000-SP	CASING,210-250TC,2-1/2 CLMP SP 225	1
5	GX10610400	CAPSCRW,HX,M12-1.75X30MM,18-8S HX HD	3
6	GX10610405	WASHER,LCK,1/2,18-8SS L SERIES	3
7	GS2600010-SC	KIT,SGL SEAL,C/N/V SP	1
	<i>GS2600010-SC</i>	<i>KIT,SGL SEAL,C/N/V SP</i>	<i>1</i>
	<i>GS2600018-SC</i>	<i>KIT,DBL SEAL,C/N/N/V SP</i>	<i>1</i>
	<i>GS2600020</i>	<i>KIT,DBL SEAL,C/C/N/V SP</i>	<i>1</i>
8	SC14620000	COVER,225,2-1/2 CLAMP SP	1
9	GX80000363	GASKET,225,CVR,BUNA SP	1
	<i>GX80000361</i>	<i>GASKET,225,CVR,EPDM SP</i>	<i>1</i>
	<i>GX80000362</i>	<i>GASKET,225,CVR,VIT SP</i>	<i>1</i>
10	SI14630000	IMPELLER,225 SP	1
11	SX15000018	KEY,210-220 SP	1
12	SI54000007	NUT,735,IMP,250TC-280TC	1
13	SX03000028	NUT,WING SP	5
14	SX10620036	GUARD,210-225,SHAFT SP	1
15	GX48104020	CAPSCRW,HX,1/4-28X3/8,18-8SS HX HD	2
16	SC1710H-SS	CAPSCRW,HX,1/2-13X1,18-8SS HX HD	4

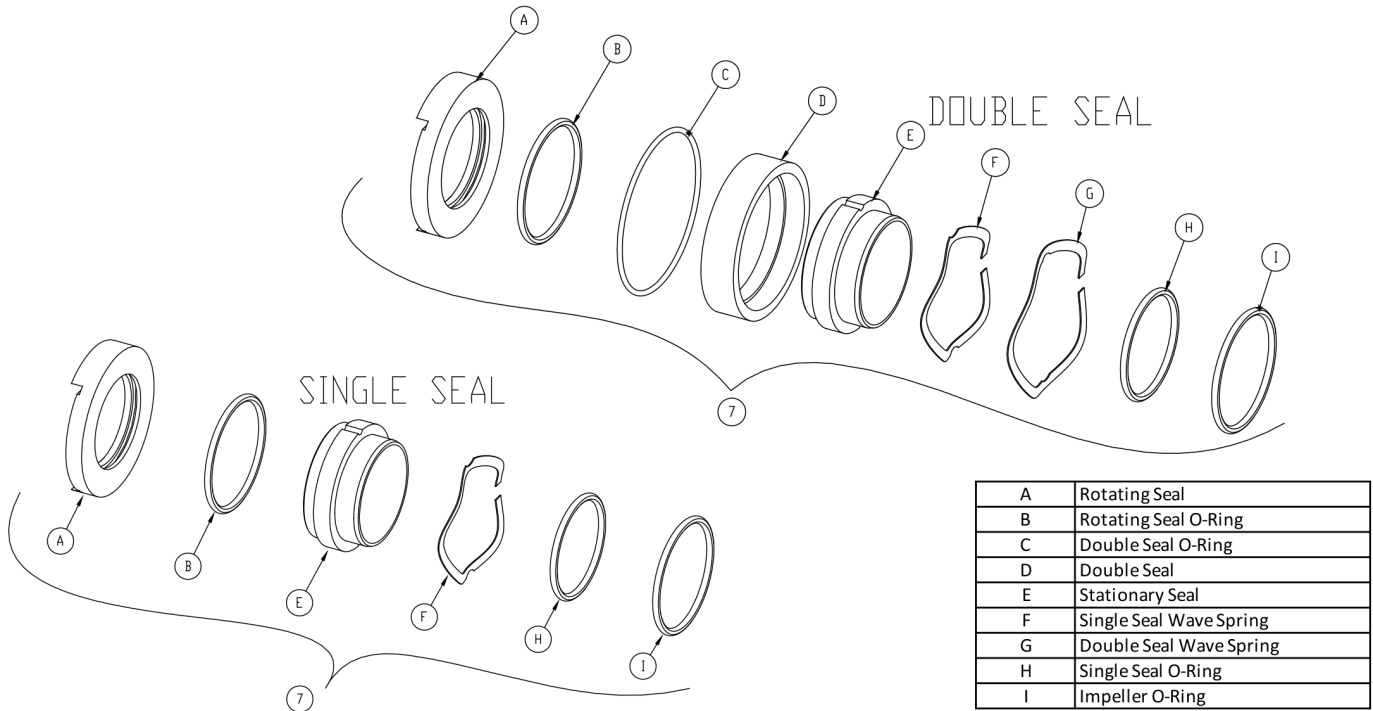

A	Rotating Seal
B	Rotating Seal O-Ring
C	Double Seal O-Ring
D	Double Seal
E	Stationary Seal
F	Single Seal Wave Spring
G	Double Seal Wave Spring
H	Single Seal O-Ring
I	Impeller O-Ring

Exploded View - Seal Only

Optional Items Shown in ITALICS

Ref #	Component Item No.	Description	Qty Per
7	GS2600010-SC	KIT,SGL SEAL,C/N/V SP	1
	<i>GS2600010-SC</i>	<i>KIT,SGL SEAL,C/N/V SP</i>	<i>1</i>
	<i>GS2600018-SC</i>	<i>KIT,DBL SEAL,C/N/N/V SP</i>	<i>1</i>
	<i>GS2600020</i>	<i>KIT,DBL SEAL,C/C/N/V SP</i>	<i>1</i>

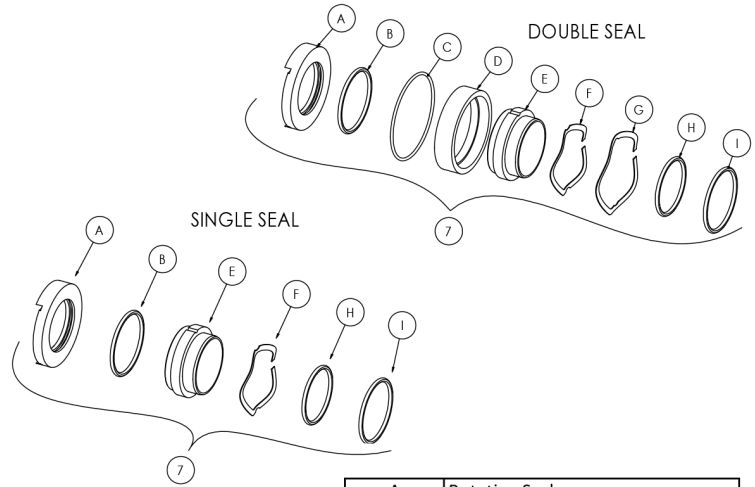
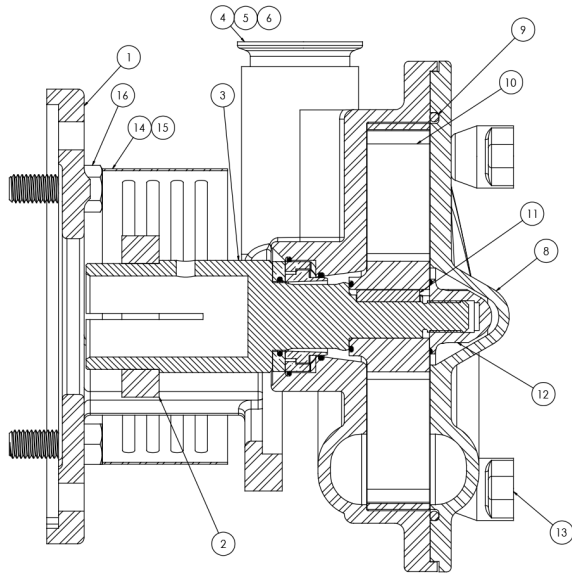

A	Rotating Seal
B	Rotating Seal O-Ring
C	Double Seal O-Ring
D	Double Seal
E	Stationary Seal
F	Single Seal Wave Spring
G	Double Seal Wave Spring
H	Single Seal O-Ring
I	Impeller O-Ring

Exploded View

Optional Items Shown in ITALICS

Ref #	Component Item No.	Description	Qty Per
1	SX10600098	ADAPTER,280 FRAME,MODIFIED SP	1
	SX8206542	PLATE,ADAPTR,280 TC SP	1
2	SX18000027	COLLAR,280TC/320TSC,SHAFT LC	1
3	SX02000280	STUBSHAFT,280TC W/KEY SP	1
4	SV14610000-SP	CASING,210-250TC,2-1/2 CLMP SP 225	1
5	GX10610400	CAPSCRW,HX,M12-1.75X30MM,18-8S HX HD	3
6	GX10610405	WASHER,LCK,1/2,18-8SS L SERIES	3
7	GS2600010-SC	KIT,SGL SEAL,C/N/V SP	1
	<i>GS2600010-SC</i>	<i>KIT,SGL SEAL,C/N/V SP</i>	1
	<i>GS2600018-SC</i>	<i>KIT,DBL SEAL,C/N/N/V SP</i>	1
	<i>GS2600020</i>	<i>KIT,DBL SEAL,C/C/N/V SP</i>	1
8	SC14620000	COVER,225,2-1/2 CLAMP SP	1
9	GX80000363	GASKET,225,CVR,BUNA SP	1
	<i>GX80000361</i>	<i>GASKET,225,CVR,EPDM SP</i>	1
	<i>GX80000362</i>	<i>GASKET,225,CVR,VIT SP</i>	1
10	SI14630000	IMPELLER,225 SP	1
11	SX15000018	KEY,210-220 SP	1
12	SI54000007	NUT,735,IMP,250TC-280TC	1
13	SX03000028	NUT,WING SP	5
14	SX10620036	GUARD,210-225,SHAFT SP	1
15	GX48104020	CAPSCRW,HX,1/4-28X3/8,18-8SS HX HD	2
16	SC1710H-SS	CAPSCRW,HX,1/2-13X1,18-8SS HX HD	8

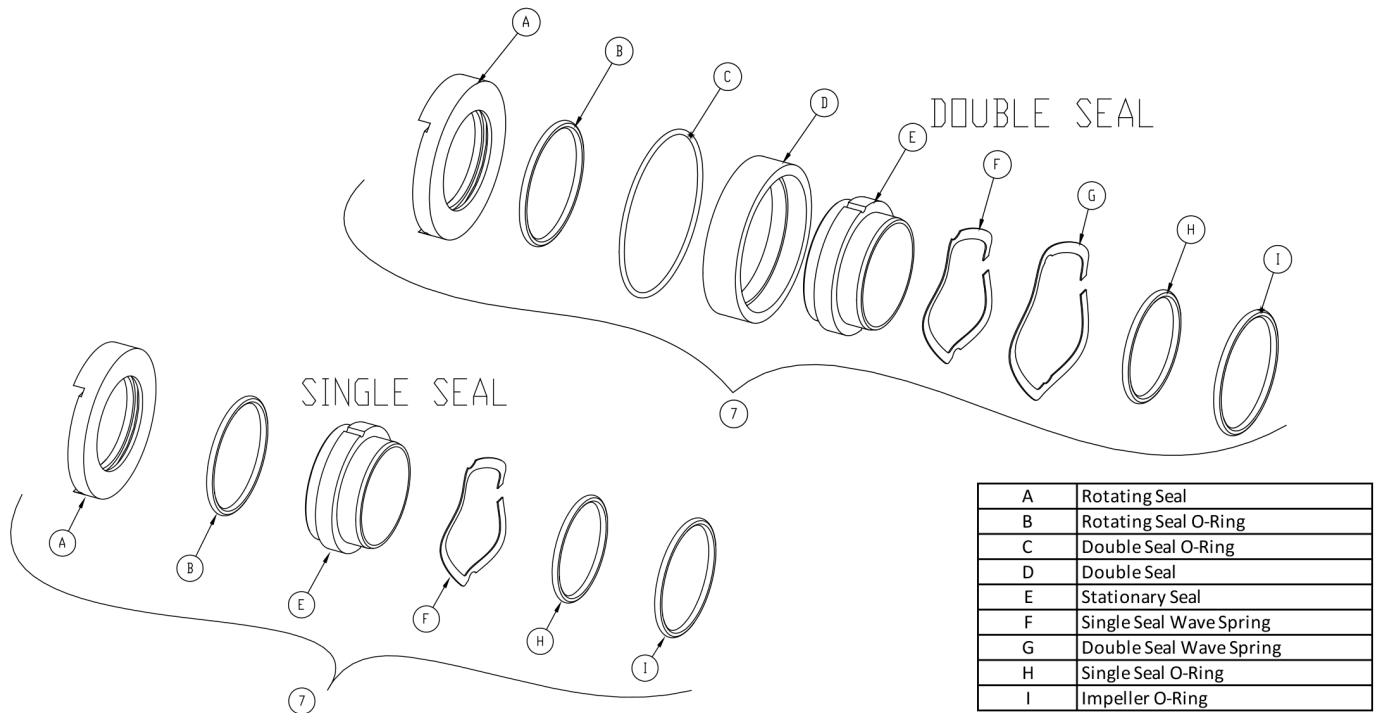

A	Rotating Seal
B	Rotating Seal O-Ring
C	Double Seal O-Ring
D	Double Seal
E	Stationary Seal
F	Single Seal Wave Spring
G	Double Seal Wave Spring
H	Single Seal O-Ring
I	Impeller O-Ring

Exploded View - Seal Only

Optional Items Shown in ITALICS

Ref #	Component Item No.	Description	Qty Per
7	GS2600010-SC	KIT,SGL SEAL,C/N/V SP	1
	<i>GS2600010-SC</i>	<i>KIT,SGL SEAL,C/N/V SP</i>	<i>1</i>
	<i>GS2600018-SC</i>	<i>KIT,DBL SEAL,C/N/N/V SP</i>	<i>1</i>
	<i>GS2600020</i>	<i>KIT,DBL SEAL,C/C/N/V SP</i>	<i>1</i>

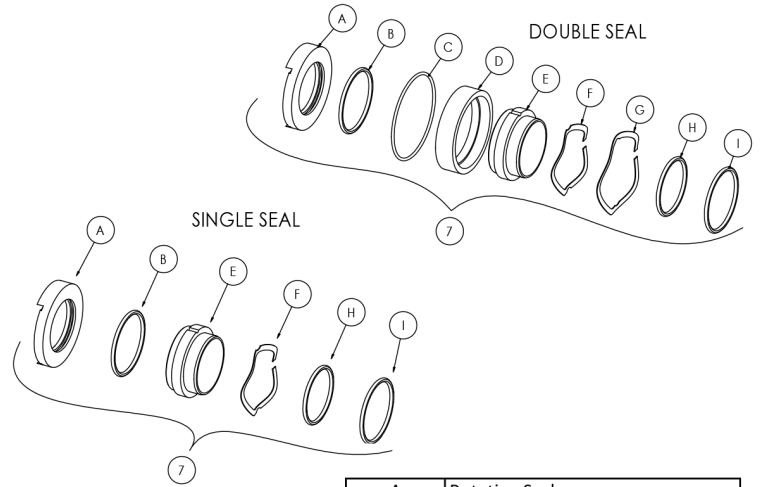
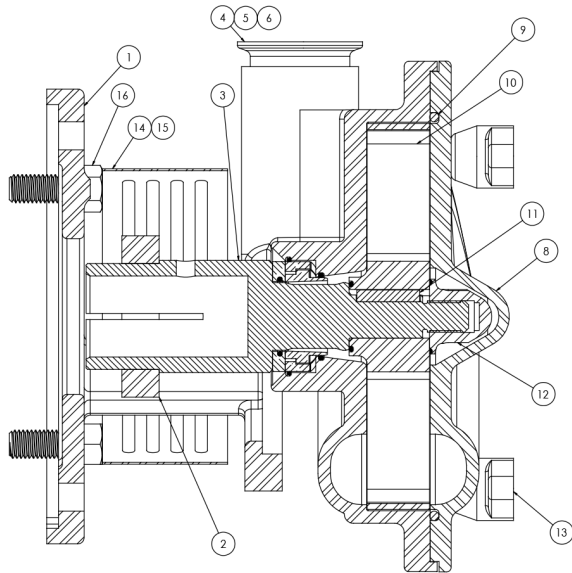

A	Rotating Seal
B	Rotating Seal O-Ring
C	Double Seal O-Ring
D	Double Seal
E	Stationary Seal
F	Single Seal Wave Spring
G	Double Seal Wave Spring
H	Single Seal O-Ring
I	Impeller O-Ring

Exploded View

Optional Items Shown in ITALICS

Ref #	Component Item No.	Description	Qty Per
1	SX10600897	ADAPTER,100/112 IEC FRAME SP	1
2	SX18000814	COLLAR,100/112 IEC,SHAFT,MTRIC	1
3	SX02000805	STUBSHAFT,100/112 IEC FRAME SP	1
4	SV14610000-SP	CASING,210-250TC,2-1/2 CLMP SP 225	1
5	GX10610400	CAPSCRW,HX,M12-1.75X30MM,18-8S HX HD	3
6	GX10610405	WASHER,LCK,1/2,18-8SS L SERIES	3
7	GS2600010-SC	KIT,SGL SEAL,C/N/V SP	1
	<i>GS2600010-SC</i>	<i>KIT,SGL SEAL,C/N/V SP</i>	<i>1</i>
	<i>GS2600018-SC</i>	<i>KIT,DBL SEAL,C/N/N/V SP</i>	<i>1</i>
	<i>GS2600020</i>	<i>KIT,DBL SEAL,C/C/N/V SP</i>	<i>1</i>
8	SC14620000	COVER,225,2-1/2 CLAMP SP	1
9	GX80000363	GASKET,225,CVR,BUNA SP	1
	<i>GX80000361</i>	<i>GASKET,225,CVR,EPDM SP</i>	<i>1</i>
	<i>GX80000362</i>	<i>GASKET,225,CVR,VIT SP</i>	<i>1</i>
10	SI14630000	IMPELLER,225 SP	1
11	SX15000018	KEY,210-220 SP	1
12	SI54000007	NUT,735,IMP,250TC-280TC	1
13	SX03000020-ACRN	NUT,ACRN,R,M12-1.75.18-8SS L/SP SERIES	5
14	SX10620836	GUARD,100/215/220,SHAFT SP 100/112/132 IEC	1
15	GX48104021	SCREW,THUMB,1/4-28X3/8,304SS L SERIES	2
16	GX5516145	CAPSCRW,HX,M14-2.0X55MM,18-8SS HX HD	4
17	GX5516010	WASHER,LOCK,M14,18-8SS	4
	GX5516015	WASHER,FLAT,M14,18-8SS	8
18	GX5516000	NUT,HEX,M14-2.0,18-8SS HEX NUT	4

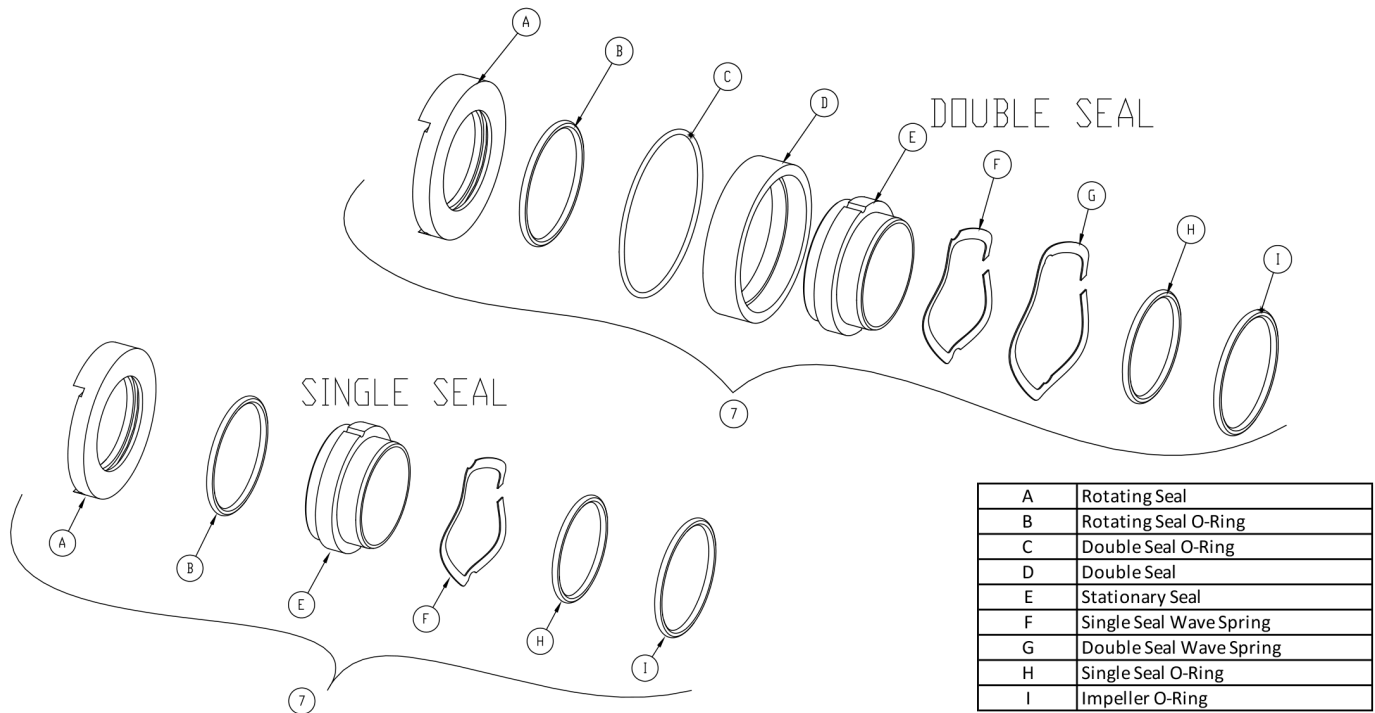

Exploded View - Seal Only

Optional Items Shown in ITALICS

Ref #	Component Item No.	Description	Qty Per
7	GS2600010-SC	KIT,SGL SEAL,C/N/V SP	1
	<i>GS2600010-SC</i>	<i>KIT,SGL SEAL,C/N/V SP</i>	<i>1</i>
	<i>GS2600018-SC</i>	<i>KIT,DBL SEAL,C/N/N/V SP</i>	<i>1</i>
	<i>GS2600020</i>	<i>KIT,DBL SEAL,C/C/N/V SP</i>	<i>1</i>

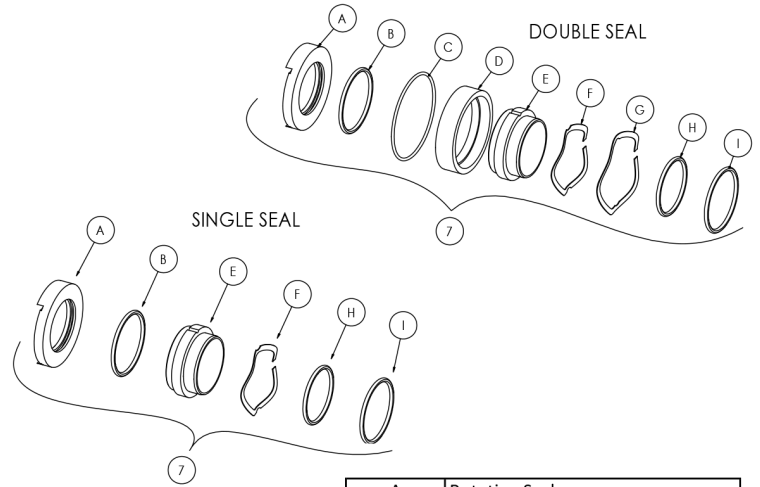
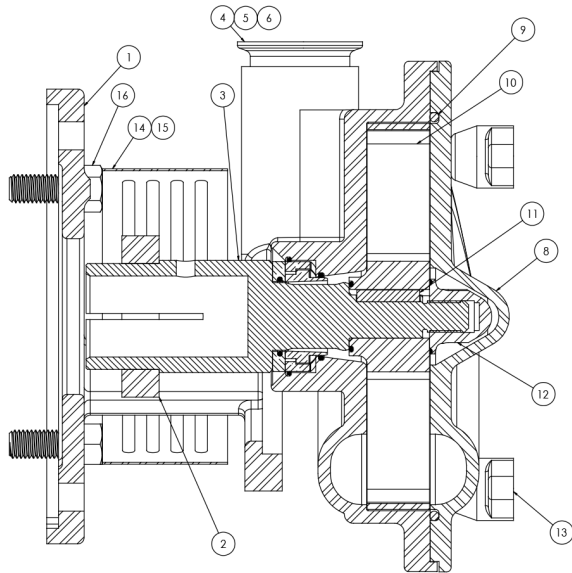

A	Rotating Seal
B	Rotating Seal O-Ring
C	Double Seal O-Ring
D	Double Seal
E	Stationary Seal
F	Single Seal Wave Spring
G	Double Seal Wave Spring
H	Single Seal O-Ring
I	Impeller O-Ring

Exploded View

Optional Items Shown in ITALICS

Ref #	Component Item No.	Description	Qty Per
1	SX10600898	ADAPTER,132 IEC FRAME SP	1
2	SX18000815	COLLAR,132 IEC,SHAFT,MTRIC	1
3	SX02000815	STUBSHAFT,132 IEC FRAME SP	1
4	SV14610000-SP	CASING,210-250TC,2-1/2 CLMP SP 225	1
5	GX10610400	CAPSCRW,HX,M12-1.75X30MM,18-8S HX HD	3
6	GX10610405	WASHER,LCK,1/2,18-8SS L SERIES	3
7	GS2600010-SC	KIT,SGL SEAL,C/N/V SP	1
	<i>GS2600010-SC</i>	<i>KIT,SGL SEAL,C/N/V SP</i>	<i>1</i>
	<i>GS2600018-SC</i>	<i>KIT,DBL SEAL,C/N/N/V SP</i>	<i>1</i>
	<i>GS2600020</i>	<i>KIT,DBL SEAL,C/C/N/V SP</i>	<i>1</i>
8	SC14620000	COVER,225,2-1/2 CLAMP SP	1
9	GX80000363	GASKET,225,CVR,BUNA SP	1
	<i>GX80000361</i>	<i>GASKET,225,CVR,EPDM SP</i>	<i>1</i>
	<i>GX80000362</i>	<i>GASKET,225,CVR,VIT SP</i>	<i>1</i>
10	SI14630000	IMPELLER,225 SP	1
11	SX15000018	KEY,210-220 SP	1
12	SI54000007	NUT,735,IMP,250TC-280TC	1
13	SX03000020-ACRN	NUT,ACRN,R,M12-1.75.18-8SS L/SP SERIES	5
14	SX10620836	GUARD,100/215/220,SHAFT SP 100/112/132 IEC	1
15	GX48104021	SCREW,THUMB,1/4-28X3/8,304SS L SERIES	2
16	GX5516150	CAPSCRW,HX,M14-2.0X60MM,18-8SS HX HD	4
17	GX5516010	WASHER,LOCK,M14,18-8SS	4
	GX5516015	WASHER,FLAT,M14,18-8SS	8
18	GX5516000	NUT,HEX,M14-2.0,18-8SS HEX NUT	4

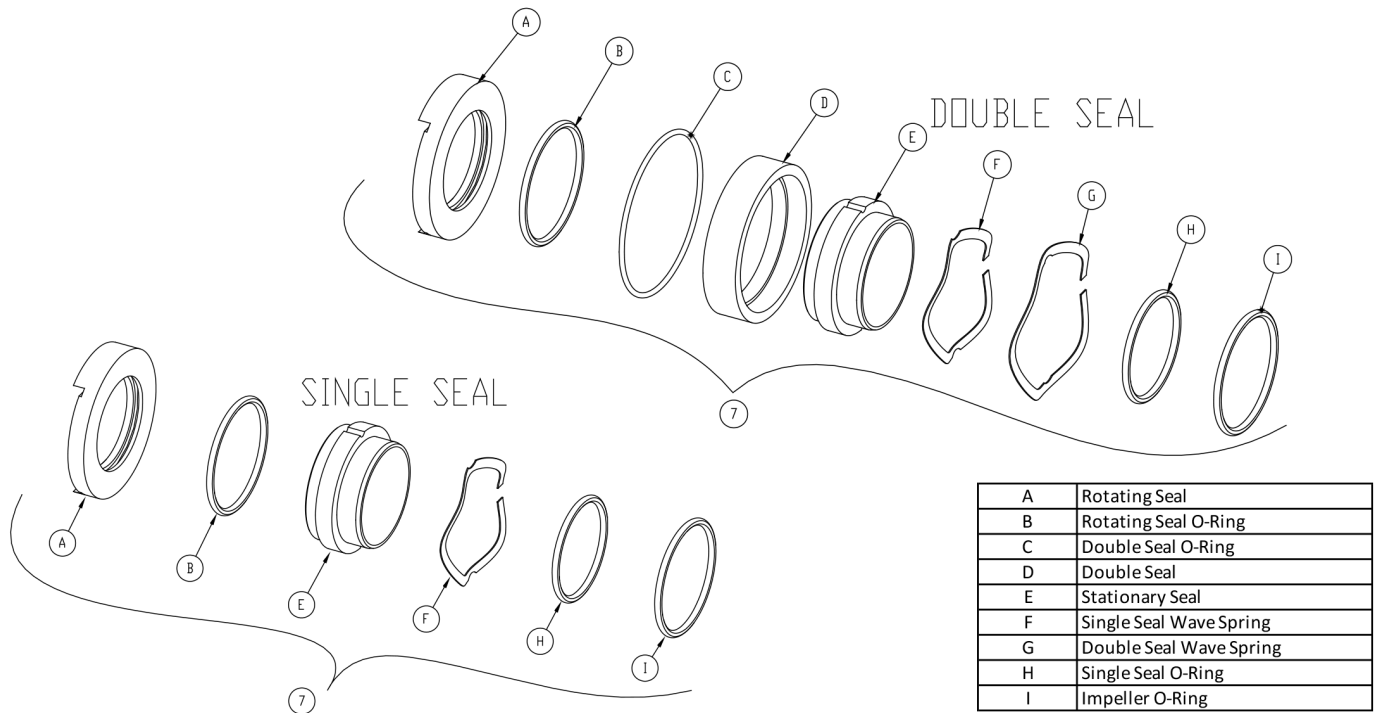

A	Rotating Seal
B	Rotating Seal O-Ring
C	Double Seal O-Ring
D	Double Seal
E	Stationary Seal
F	Single Seal Wave Spring
G	Double Seal Wave Spring
H	Single Seal O-Ring
I	Impeller O-Ring

Exploded View - Seal Only

Optional Items Shown in ITALICS

Ref #	Component Item No.	Description	Qty Per
7	GS2600010-SC	KIT,SGL SEAL,C/N/V SP	1
	<i>GS2600010-SC</i>	<i>KIT,SGL SEAL,C/N/V SP</i>	<i>1</i>
	<i>GS2600018-SC</i>	<i>KIT,DBL SEAL,C/N/N/V SP</i>	<i>1</i>
	<i>GS2600020</i>	<i>KIT,DBL SEAL,C/C/N/V SP</i>	<i>1</i>

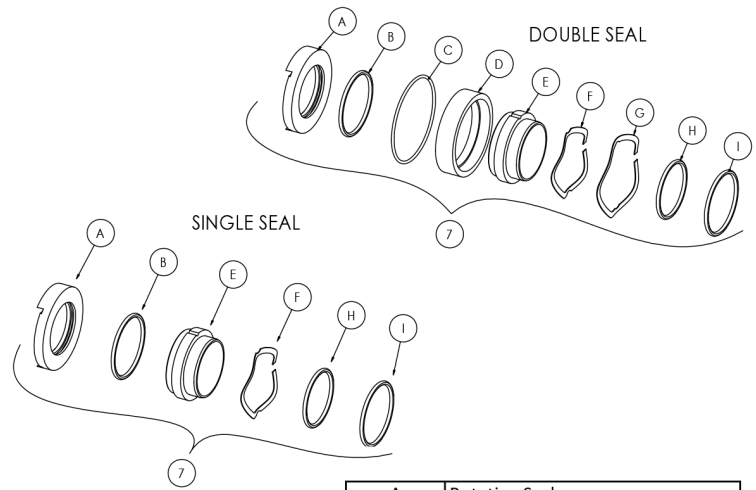
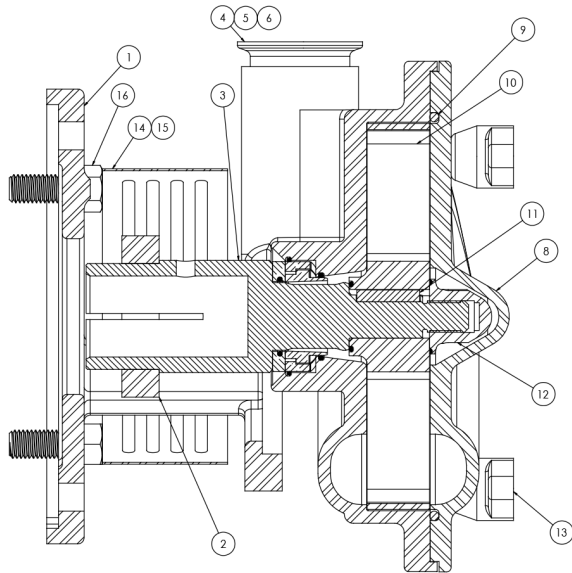

A	Rotating Seal
B	Rotating Seal O-Ring
C	Double Seal O-Ring
D	Double Seal
E	Stationary Seal
F	Single Seal Wave Spring
G	Double Seal Wave Spring
H	Single Seal O-Ring
I	Impeller O-Ring

Exploded View

Optional Items Shown in ITALICS

Ref #	Component Item No.	Description	Qty Per
1	SX10600899	ADAPTER,160 IEC FRAME SP	1
2	SX18000816	COLLAR,160,IEC,SHAFT,MTRIC	1
3	SX02000823	STUBSHAFT,160 IEC FRAME SP	1
4	SV14610000-SP	CASING,210-250TC,2-1/2 CLMP SP 225	1
5	GX10610400	CAPSCRW,HX,M12-1.75X30MM,18-8S HX HD	3
6	GX10610405	WASHER,LCK,1/2,18-8SS L SERIES	3
7	GS2600010-SC	KIT,SGL SEAL,C/N/V SP	1
	<i>GS2600010-SC</i>	<i>KIT,SGL SEAL,C/N/V SP</i>	<i>1</i>
	<i>GS2600018-SC</i>	<i>KIT,DBL SEAL,C/N/N/V SP</i>	<i>1</i>
	<i>GS2600020</i>	<i>KIT,DBL SEAL,C/C/N/V SP</i>	<i>1</i>
8	SC14620000	COVER,225,2-1/2 CLAMP SP	1
9	GX80000363	GASKET,225,CVR,BUNA SP	1
	<i>GX80000361</i>	<i>GASKET,225,CVR,EPDM SP</i>	<i>1</i>
	<i>GX80000362</i>	<i>GASKET,225,CVR,VIT SP</i>	<i>1</i>
10	SI14630000	IMPELLER,225 SP	1
11	SX15000018	KEY,210-220 SP	1
12	SI54000007	NUT,735,IMP,250TC-280TC	1
13	SX03000020-ACRN	NUT,ACRN,R,M12-1.75.18-8SS L/SP SERIES	5
14	SX10620837	GUARD,225,SHAFT,160IEC SP	1
15	GX48104021	SCREW,THUMB,1/4-28X3/8,304SS L SERIES	2
16	GX5518170	CAPSCRW,HX,M18-2.5X70MM,18-8SS HX HD	4
17	GX5518010	WASHER,LOCK,M18,18-8SS	4
	GX5518015	WASHER,FLAT,M18,18-8SS	8
18	GX5518000	NUT,HEX,M18-2.5,18-8SS HEX NUT	4

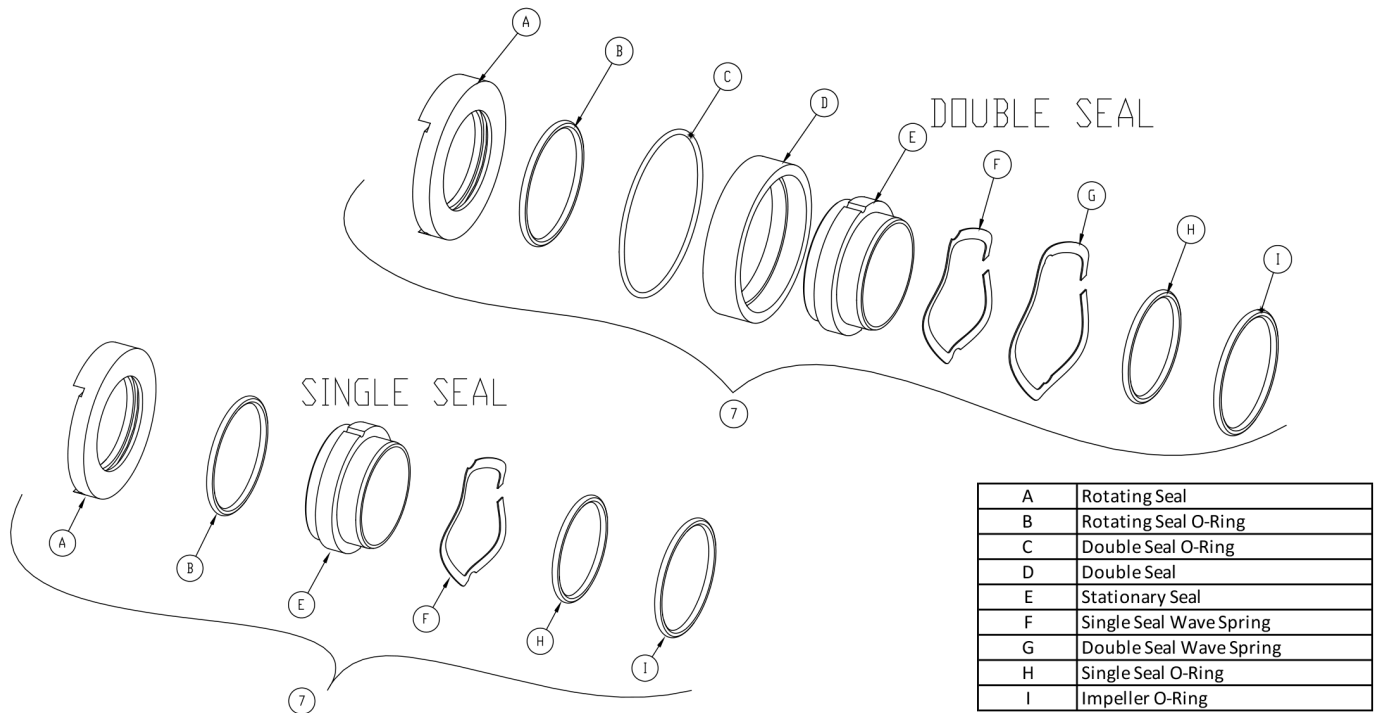

A	Rotating Seal
B	Rotating Seal O-Ring
C	Double Seal O-Ring
D	Double Seal
E	Stationary Seal
F	Single Seal Wave Spring
G	Double Seal Wave Spring
H	Single Seal O-Ring
I	Impeller O-Ring

Exploded View - Seal Only

Optional Items Shown in ITALICS

Ref #	Component Item No.	Description	Qty Per
7	GS2600010-SC	KIT,SGL SEAL,C/N/V SP	1
	<i>GS2600010-SC</i>	<i>KIT,SGL SEAL,C/N/V SP</i>	<i>1</i>
	<i>GS2600018-SC</i>	<i>KIT,DBL SEAL,C/N/N/V SP</i>	<i>1</i>
	<i>GS2600020</i>	<i>KIT,DBL SEAL,C/C/N/V SP</i>	<i>1</i>

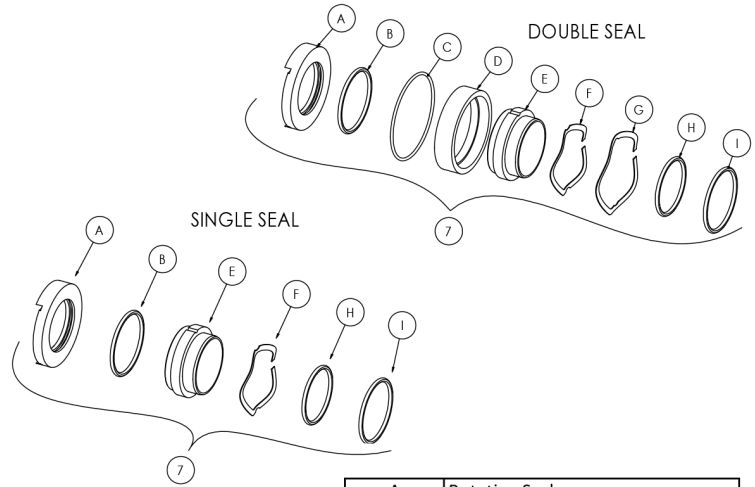
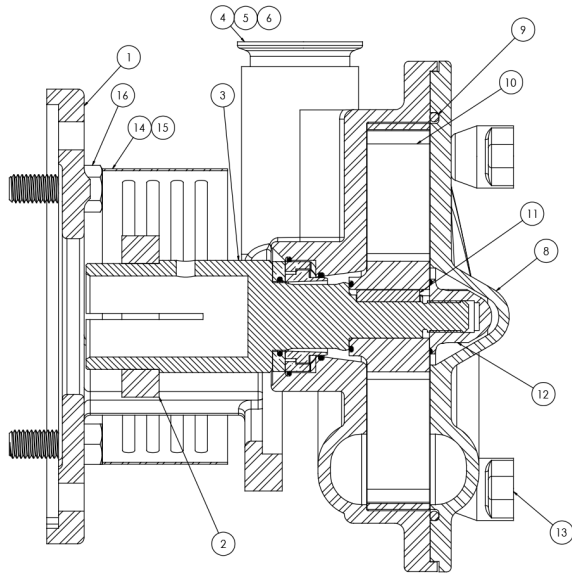

A	Rotating Seal
B	Rotating Seal O-Ring
C	Double Seal O-Ring
D	Double Seal
E	Stationary Seal
F	Single Seal Wave Spring
G	Double Seal Wave Spring
H	Single Seal O-Ring
I	Impeller O-Ring

Exploded View

Optional Items Shown in ITALICS

Ref #	Component Item No.	Description	Qty Per
1	SX10600899	ADAPTER,160 IEC FRAME SP	1
2	SX18000027	COLLAR,280TC/320TSC,SHAFT LC	1
3	SX02000830	STUBSHAFT,180 IEC FRAME SP	1
4	SV14610000-SP	CASING,210-250TC,2-1/2 CLMP SP 225	1
5	GX10610400	CAPSCRW,HX,M12-1.75X30MM,18-8S HX HD	3
6	GX10610405	WASHER,LCK,1/2,18-8SS L SERIES	3
7	GS2600010-SC	KIT,SGL SEAL,C/N/V SP	1
	<i>GS2600010-SC</i>	<i>KIT,SGL SEAL,C/N/V SP</i>	<i>1</i>
	<i>GS2600018-SC</i>	<i>KIT,DBL SEAL,C/N/N/V SP</i>	<i>1</i>
	<i>GS2600020</i>	<i>KIT,DBL SEAL,C/C/N/V SP</i>	<i>1</i>
8	SC14620000	COVER,225,2-1/2 CLAMP SP	1
9	GX80000363	GASKET,225,CVR,BUNA SP	1
	<i>GX80000361</i>	<i>GASKET,225,CVR,EPDM SP</i>	<i>1</i>
	<i>GX80000362</i>	<i>GASKET,225,CVR,VIT SP</i>	<i>1</i>
10	SI14630000	IMPELLER,225 SP	1
11	SX15000018	KEY,210-220 SP	1
12	SI54000007	NUT,735,IMP,250TC-280TC	1
13	SX03000020-ACRN	NUT,ACRN,R,M12-1.75.18-8SS L/SP SERIES	5
14	SX10620837	GUARD,225,SHAFT,160IEC SP	1
15	GX48104021	SCREW,THUMB,1/4-28X3/8,304SS L SERIES	2
16	GX5518170	CAPSCRW,HX,M18-2.5X70MM,18-8SS HX HD	4
17	GX5518010	WASHER,LOCK,M18,18-8SS	4
	GX5518015	WASHER,FLAT,M18,18-8SS	8
18	GX5518000	NUT,HEX,M18-2.5,18-8SS HEX NUT	4

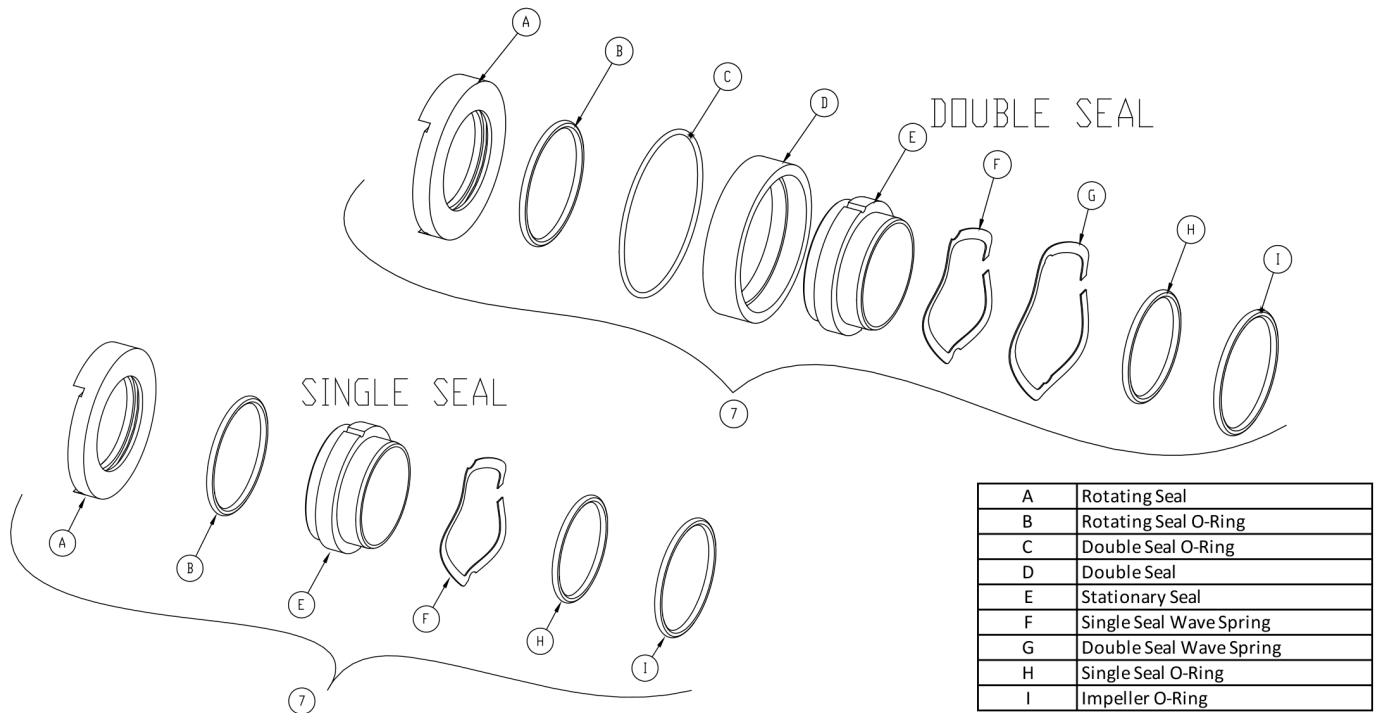

Exploded View - Seal Only

Optional Items Shown in ITALICS

Ref #	Component Item No.	Description	Qty Per
7	GS2600010-SC	KIT,SGL SEAL,C/N/V SP	1
	<i>GS2600010-SC</i>	<i>KIT,SGL SEAL,C/N/V SP</i>	<i>1</i>
	<i>GS2600018-SC</i>	<i>KIT,DBL SEAL,C/N/N/V SP</i>	<i>1</i>
	<i>GS2600020</i>	<i>KIT,DBL SEAL,C/C/N/V SP</i>	<i>1</i>

AMPCO PUMPS
Made of SELECTED corrosion-resistant alloys

TERMS AND CONDITIONS OF SALE

- 1. ENTIRE AGREEMENT.** This document contains all of the terms and conditions of the agreement (“the agreement”) between Ampco Pumps Company, Inc. (“Seller”) and the purchaser (“Purchaser”) of the Products (“Products”) to be sold to Purchaser, to the exclusion of any other statements and agreements, and to the exclusion of any terms and conditions incorporated in Purchaser’s order or other documents of Purchaser. Seller’s acceptance of Purchaser’s order is expressly conditioned on Purchaser’s acceptance of the terms and conditions contained herein, and Purchaser, upon placing an order, is presumed to have accepted all the terms and conditions without modification. No alteration, waiver, modification of or addition to the terms and conditions herein shall be binding on Seller unless set forth in writing and specifically agreed to by an officer of Seller. No course of dealing, usage of trade or course of performance will be relevant to supplement or explain any terms used in the agreement. All offers to purchase, quotations and contracts of sale are subject to final acceptance by Seller at its home office at Milwaukee, Wisconsin.
- 2. PRICES.** Prices for Products manufactured by Seller pursuant to written accepted orders will remain firm for thirty (30) days from the date of any subsequent price change.
- 3. TERMS OF PAYMENT.** Standard terms are ½% 10 days, 30 days net, from date of invoice unless otherwise stated. If, in the judgment of Seller, the financial condition of Purchaser at any time does not justify continuance of production or shipment on the terms of payment specified, Seller may require full or partial payment in advance. In cases of delays in payment, Seller reserves the right to charge interest on delinquent balances at the rate of 1 ½% per month.
- 4. DELIVERY.** Except as otherwise provided expressly stated in the agreement, Products are sold F.O.B. Milwaukee. Seller will use reasonable commercial efforts to fill orders within the time stated, but the stated delivery date is approximate only, and Seller reserves the right to readjust shipment schedules without liability. Acceptance by Purchaser of the Products waives any claim for loss or damage resulting from a delay, regardless of the cause of the delay. Except as otherwise provided herein, Seller will not be responsible for freight, transportation, insurance, shipping, storage, handling, demurrage or similar charges. Claims by Purchaser for shortages in the Products must be made to Seller in writing within ten (10) days after date of receipt of the Products. No such shortage shall entitle Purchaser to withhold payment for Products which were received by Purchaser. Each such claim shall set forth in detail the basis and amount of such claim.
- 5. TAXES AND FEES.** Seller shall pay all present and future sales, excise, privilege, use or other taxes, customs duties, and all other fees or other costs, imposed by any federal, state, foreign, or local authorities arising from the sale, purchase, transportation, delivery, storage, use or consumption of the Products or will, if applicable, provide Seller with an appropriate exemption certificate. Seller shall be under no obligation to contest the validity of any such taxes or to prosecute any claims for refunds or returns.
- 6. INSTALLATION.** The Products shall be installed by and at the expense of Purchaser.
- 7. LOSS, DAMAGE OR DELAY.** Seller will not be liable for loss, damage or delay resulting from causes beyond its reasonable control, including, without limitation, strikes or labor difficulties, lockouts, acts or omissions of any governmental authority or Seller, insurrection or riot, war, fires, floods, Acts of God, breakdown of essential machinery, accidents, embargoes, cargo or material shortages, delays in transportation, lack of production capacity or inability to obtain labor, materials or parts from usual sources. In the event of any such delay, performance will be postponed by such length of time as may be reasonably necessary to compensate for the delay. In the event performance by Seller under the agreement cannot be accomplished by Seller due to any of the foregoing causes within a reasonable period of time, Seller may, at its option, terminate the agreement without liability.
- 8. RETURNS.** No Products or parts may be returned by Purchaser without the prior written consent of Seller.
- 9. WARRANTY.** Seller warrants that the Products manufactured by Seller will be free from defects, material and workmanship under normal use and service for a period of one (1) year from date of shipment. In addition, the specified rating of each pump is warranted; however, the characteristic shape of the performance curves may vary from the published standards, and the capacity, head and efficiency guarantees are based on actual shop tests using clear cold water, and therefore the rating is specified in equivalent units of clear cold water. The sole obligation of Seller and the exclusive remedy of Purchaser for breach of this warranty shall be the repair (at Seller’s facility) or replacement by Seller (F.O.B. Milwaukee, Wisconsin), at Seller’s option, of any parts found to be defective, without charge and shall be conditioned upon Seller receiving written notice of any alleged breach of this warranty within a reasonable time after discovery of the defects, but in no event later than the end of the warranty period. The parts alleged to be defective shall be returned to Seller upon its request, freight prepaid. This warranty does not cover ordinary wear and tear, abuse, misuse, overloading, alteration or Products or parts which have not been installed, operated or maintained in accordance with Seller’s written instructions. Seller shall not be liable for any expenses for repairs, additions or modifications to the Products outside of Seller’s factory without its prior written consent, and any such repairs without such consent shall void this warranty. **THIS WARRANTY IS EXCLUSIVE AND IS IN LIEU OF ALL OTHER EXPRESS AND IMPLIED WARRANTIES WHATSOEVER, INCLUDING BUT NOT LIMITED TO IMPLIED WARRANTIES OF MERCHANTABILITY AND FITNESS FOR A PARTICULAR PURPOSE.** Seller may from time to time provide its facilities, personnel and experience to assist customers in the selection of materials, design, installation and operation of Products for maximum resistance to corrosion and abrasion with due consideration to the economy of the installation. This service is provided in an advisory capacity only and the final selection and operation of the Products and ancillary equipment shall be the sole responsibility of Purchaser or any user thereof. Accessories and parts manufactured by third parties are warranted only to the extent of such third party’s warranty. **IN NO EVENT SHALL SELLER BE LIABLE UNDER ANY CIRCUMSTANCES FOR ANY INCIDENTAL, CONSEQUENTIAL OR SPECIAL DAMAGES (INCLUDING, WITHOUT LIMITATION, ANY LOST PROFITS OR LABOR COSTS) ARISING FROM THE BREACH OF THIS WARRANTY OR OTHERWISE ARISING FROM OR RELATING TO THE PRODUCTS OR THEIR SALE, USE OR INSTALLATION.**
- 10. CHANGES.** Changes in any work to be performed hereunder may be made only upon Purchaser’s written instructions and acceptance by Seller in its discretion. Any change in drawings, materials or design of the Products, or to tools, fixtures or other items used to produce the Products, which affects Seller’s cost to produce the Products will entitle Seller to adjust the price to take into account any additional costs. If work has been started, Seller shall be properly reimbursed for work already performed; if Products already produced are not accepted by Purchaser, Seller has the right to adjust the price to take into account any additional costs caused by an increase or decrease in quantities or in the time required for performance under the agreement.
- 11. TERMINATION.** After Seller has commenced work, ordered any materials or made any other commitments pursuant to the agreement, it may be terminated only with the prior written agreement of Seller providing for equitable cancellation charges. Such charges shall reimburse Seller for any completed items at the contract price, and for any work-in-process items at the contract price less the cost to complete. Termination on any other basis must be specifically agreed on in writing in advance between Purchaser and Seller.
- 12. DEFERRED DELIVERIES.** Orders or deliveries will be deferred only upon the prior written agreement of Seller in its discretion, and then only upon the following conditions:

(a) The deferral period may not exceed sixty (60) days. At the end of the deferral period, if no release is provided by Purchaser, Seller reserves the right to render an invoice for and ship the completed portion of the order to the destination specified in Purchaser's order, or to store such material at Purchaser's expense at Seller's standard storage charges then in effect.

(b) For the portion of the order that is not completed, if no release is provided by Purchaser at the expiration of the deferral period, Seller reserves the right to render an invoice for any completed items at the contract price, and for any work-in-process items at the contract price less the cost to complete.

(c) Purchaser shall bear the risk of loss or damage to materials held at Purchaser's request.

13. LIMITATION OF LIABILITY. IN NO EVENT SHALL SELLER BE LIABLE UNDER ANY CIRCUMSTANCES: (a) FOR ANY INCIDENTAL, CONSEQUENTIAL OR SPECIAL DAMAGES (INCLUDING, WITHOUT LIMITATION, ANY LOST PROFITS OR LABOR COSTS) ARISING FROM OR RELATING TO THE PRODUCTS OR THEIR SALE, USE OR INSTALLATION; (b) FOR DAMAGES TO PROPERTY (OTHER THAN THE PRODUCTS PURCHASED FROM SELLER); (c) FROM ANY BREACH OF ITS WARRANTY OR ANY OTHER OBLIGATIONS TO BUYER; OR (d) FOR ANY OTHER CAUSE WHATSOEVER, WHETHER BASED ON WARRANTY (EXPRESSED OR IMPLIED) OR OTHERWISE BASED ON CONTRACT, OR ON TORT OR OTHER THEORY OF LIABILITY, AND REGARDLESS OF ANY ADVICE OR REPRESENTATIONS (WHETHER OR NOT IN WRITING) THAT MAY HAVE BEEN RENDERED BY SELLER CONCERNING THE DESIGN, MANUFACTURE, SALE, USE OR INSTALLATION OF THE PRODUCTS.

14. INFRINGEMENT. Seller at its expense will defend and hold Purchaser harmless from and against all damages, costs and expenses arising from any valid claim of infringement by a third party with respect to any patent or other intellectual property rights (collectively, the "Intellectual Property Rights") caused by Products originally manufactured by Seller, provided Purchaser (a) has not modified such Products, (b) gives Seller immediate notice in writing of any claim or commencement or threat of suit, and (c) permits Seller to defend or settle the same, and gives all immediate information, assistance and authority to enable Seller to do so. In the event any such originally manufactured Products are held to infringe an Intellectual Property Right and if Purchaser's use thereof is enjoined, Seller will, at its expense and option: (1) obtain for Purchaser the right to continue using the Products, (2) supply non-infringing Products, (3) modify the Products so that they become non-infringing, or (4) refund the then market value of such Products. In no event shall Seller's liability exceed the sale price of the infringing Products. THE FOREGOING REPRESENTS SELLER'S ENTIRE AND EXCLUSIVE OBLIGATION WITH RESPECT TO ANY CHARGE OF INFRINGEMENT OF ANY INTELLECTUAL PROPERTY RIGHT AND IS IN LIEU OF ANY STATUTORY WARRANTY RELATING TO INFRINGEMENT. Notwithstanding the foregoing, Seller shall have no liability as to any Products or parts thereof that are manufactured or modified by Purchaser or a third party, or that are manufactured or modified by Seller in accordance with Purchaser's specifications. Purchaser will defend and hold Seller harmless from and against all damages, costs and expenses whatsoever arising from any claim for infringement of any Intellectual Property Rights relating to Products that have been manufactured or modified by Seller according to specifications provided by Purchaser.

15. CERTAIN LAWS. Seller will comply with the applicable requirements of the Fair Labor Standards Act of 1938, as amended, Executive Order 11246, and THE rules, regulations and orders of the Secretary of Labor relating thereto.

16. PERIOD FOR ACCEPTING QUOTATIONS. Unless accepted without modification within thirty (30) days of issuance, or prior to withdrawal by Seller if earlier, all quotations automatically expire at the end of such thirty (30) day period.

17. PROVISIONS FOR INTERNATIONAL TRANSACTIONS. The following provisions shall apply if the Products are to be shipped to Purchaser at a location outside the United States, and apply regardless of other provisions set forth in these Terms and Conditions:

(a) The 1980 United Nations Convention on Contracts for the International Sale of Products shall not apply.

(b) Except as otherwise provided expressly stated in the agreement, terms of delivery are Ex-Works (within the meaning of INCOTERMS 2000) and all customs fees, import duties, cargo insurance, taxes and other charges imposed on or relating to the purchase or sale of the Products shall be paid by Purchaser in addition to the stated price.

(c) Except as otherwise provided expressly stated elsewhere in the agreement, payment shall be made by issuance to Seller of an irrevocable letter of credit which (i) is issued and confirmed by a U.S. bank acceptable to Seller, (ii) is governed by the Uniform Customs and Practice for Documentary Credits (UCP 600) and otherwise acceptable in form and substance to Seller, and (iii) provides for payment to Seller of the purchase price in U.S. dollars upon presentation by Seller of Seller's certification and/or such other documents as shall be required by the letter of credit. All banking and other charges for such letter of credit shall be for the account of Purchaser.

(d) Prices include Seller's standard commercial export packaging which may vary depending on whether shipment is made by air, land or sea. Except as otherwise provided expressly stated in the agreement, Purchaser will bear any additional expenses required to satisfy Purchaser's packaging requirements. Packages will be marked in accordance with Purchaser's instructions, if any. Seller shall furnish packing lists and such other information as may be necessary to enable Purchaser's agent to prepare documents required for export shipment.

(e) All shipments hereunder are subject to compliance with the U.S. Export Administration Act, as amended, regulations thereunder and all other U.S. laws and regulations concerning exports. Purchaser shall comply with all such laws and regulations concerning the use, disposition, re-export and sale of the Products provided hereunder.

18. GENERAL. No modification or waiver of the agreement or any of its provisions is valid unless expressly agreed to by Seller in writing, and no waiver by Seller of any default under the agreement is a waiver of any other or subsequent default. The unenforceability or invalidity of one or more of the provisions of the agreement will not affect the enforceability or validity of any other provision of the agreement. Purchaser may not assign any of its rights, duties or obligations under the agreement without Seller's prior written consent and any attempted assignment without such consent, even if by operation of law, will be void. The agreement is governed by and shall be construed in accordance with the laws of the State of Wisconsin, including the Uniform Commercial Code as enacted by such state, without giving effect to its conflict of laws principles.

Ampco Pumps Company, Inc.
2045 W. Mill Road
Glendale, WI 53209
(414) 643-1852
(414) 643-4452 fax

Ampco Pumps Company

Return Policy

This policy is intended for returns that are not covered by product warranty, i.e. wrong pump or part was ordered, customer canceled order, etc. Before returning any product, contact us for a Returned Material Authorization Number (RMA#). This will eliminate confusion when the parts are received and facilitate processing the return. No action will be taken on returned parts without an RMA.

<u>Type of Return</u>	<u>Restocking Charge</u>
Standard pump with a replacement order	10%
Standard pump without a replacement order	15%
Standard parts with a replacement order	5%
Standard parts without a replacement order	10%

Additional restocking charges may be assessed for any of the following circumstances.

1. Special order motors and seals are not returnable unless we have a use for them. Credit will be determined on a case-by-case basis.
2. Impellers that are trimmed to a diameter that we don't regularly use are not returnable. Credit will be determined on a case-by-case basis.
3. Used seals and motors are not returnable.

Credits

Credit will be issued only after parts are returned and inspected. Customer is responsible for packaging parts so they are returned in "as new" condition. Any labor required by Ampco to return the parts to "as new" condition will be deducted from the credit.